

**Crowdfunded, free copy  
– not for sale –**

**9/11, nuclear weapons and secret societies**

Transcription of a talk given to the  
London 9/11Keep talking group on  
April 4<sup>th</sup>, 2017

by Heinz Pommer





**Crowdfunded, free copy  
– not for sale –**

**9/11, nuclear weapons and secret societies**

Transcription of a talk given to the  
London 9/11Keep talking group on  
April 4<sup>th</sup>, 2017

by Heinz Pommer

---

Every coin goes into publishing and distribution !

bitcoin code:



bitcoin account:

1DDGLybQEmmT9c28Pj6JrdCV7Arsk1yQeh

# The situation: warmongers in power

But the 9/11 deceivers were deceived – and lured into servitude.

“And no wonder, for Satan himself masquerades as an angel of light.”

**2 Corinthians 11:14**

## The way out

The key element of the oligarchs' mind game is fear – or angst.

On the spiritual side you will always win, dropping the angst:

- trust in your spiritual self

There is just one way out: the continuous **and personal** search for truth, justice and peace, which is the only option.

For all of us.

To disarm the devil – and not to serve him.

## Website

Additional information and video clips are available at:

[www.911history.de](http://www.911history.de)



How did they fool us, the 9/11-experts, the paid collaborators?

How is it that our institutions continue to fail us?

Denial and deception made us believe:

- that we were shown all of the physical 9/11-evidence  
... when so much remains hidden from the public eyes
- that we were told the truth about modern nuclear weapons  
... when they explain us the technology from 1945 – or fiction
- that our modern country is governed by its legal civic institutions  
... when the control of money resides in the hand of private banks

### The three keys to 9/11

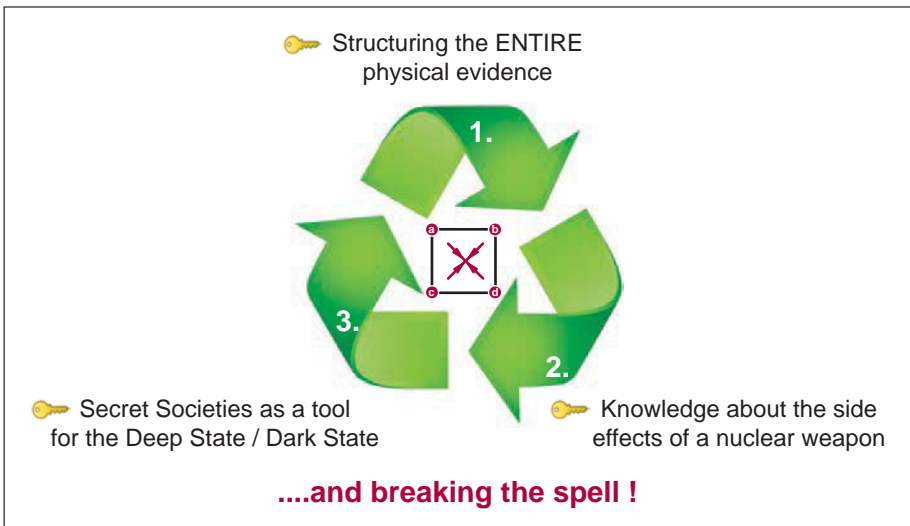

on 9/11, three steel frame buildings...

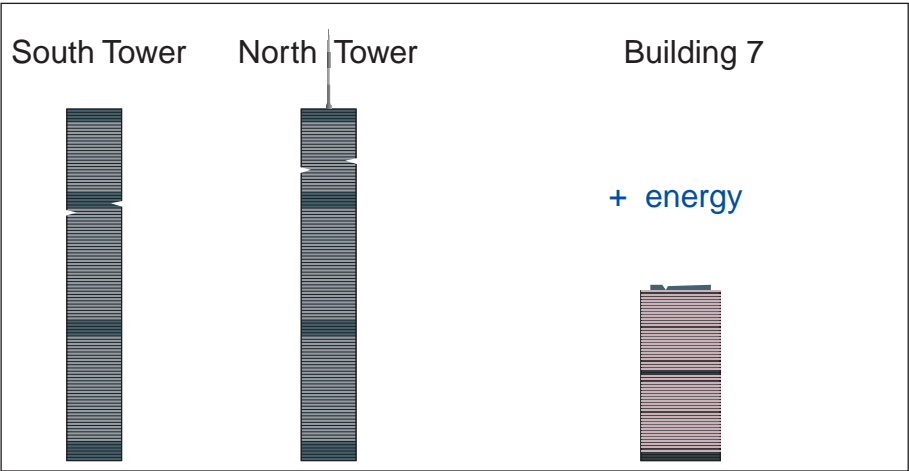

...ended up in plumes of black, hot dust



Source 1: <http://911research.com/wtc/evidence/photos/wtc1exp10.html>

Source 2: @13:10: <http://www.youtube.com/watch?v=JnLcUxV1dPo>

...and puddles of molten steel in the rock

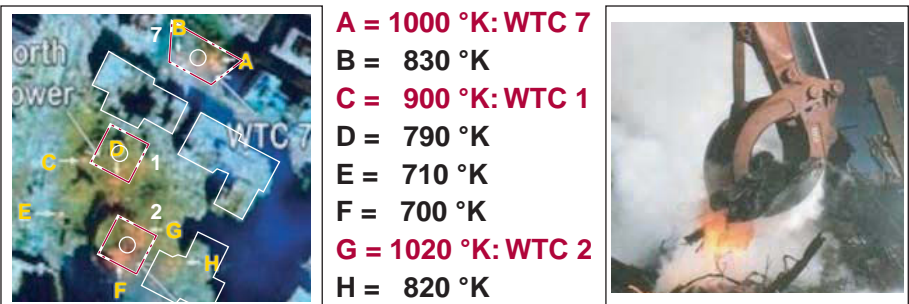

Source: <https://pubs.usgs.gov/of/2001/ofr-01-0429/thermal.r09.html>

# 1 Introduction

## A trip to London

On April 4th 2017, I traveled to the UK to give a presentation to the 9/11Keepertalking Group at the Diorama Arts Centre in Central London.

Although the subject was a fairly sinister one, it was not my intention to discourage the public: I wanted to deliver a message of hope.

## The gift of 9/11

Our knowledge has become dangerous to the power elite.

We know that wars have been started on basis of the 9/11-deception.

We know that a future civil war in Europe is currently in the making, when the artificial migrant crisis spins out of 'control'.

The scenario of a collapsing dollar, the implosion of the US and the simultaneous creation of the 'North American Union' is ready to unfold.

This is the gift of 9/11: to see behind the curtain and stop the crimes.



Source: <https://911justicehalifax.files.wordpress.com/2013/12/gjs-wtc56.jpg>

## 2 The power of simplicity

The two ruling parameters for any physical system are:

- energy
- momentum

### The 9/11-energy equation

Many organizations have observed that a plane and its fuel load can't be the real cause of a building's extremely powerful eruption.

Most of them come to the conclusion that only pre-planted explosives inside the structure could account for the additional energy.

Inevitably, they start talking about floor-by-floor detonations, destroying the building from top downwards.

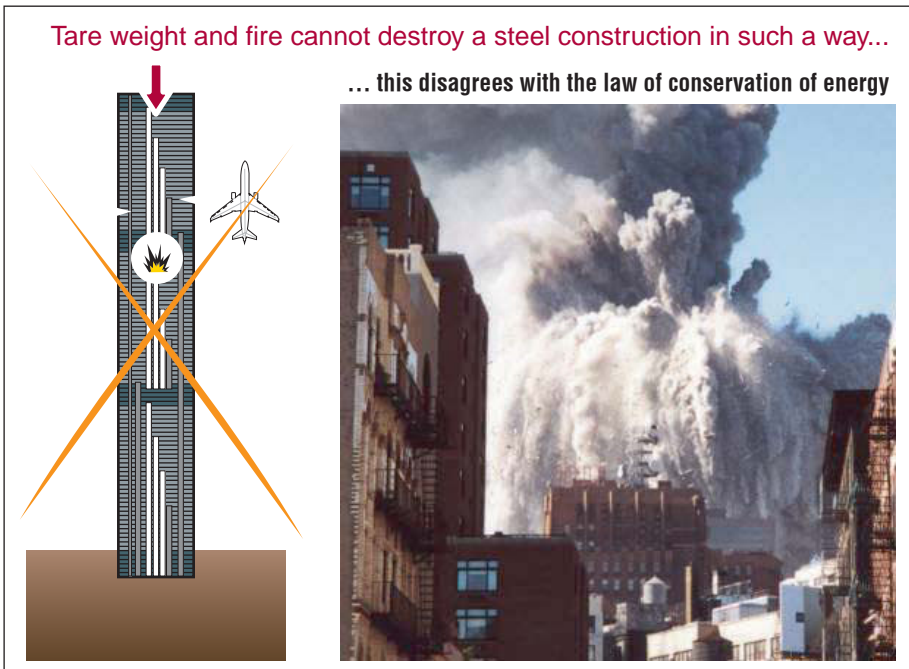

Source (photo): <http://911research.wtc7.net/wtc/evidence/photos/wtc1exp10.html>

## The 9/11-momentum and material ejection

However, pre-planted explosives in separate floors can produce only:

- circular shockwaves out of the corresponding floor

As these circular shockwaves cannot change direction after the explosion, they will NEVER form a uniform fountain.

---

**Key question: what can produce such a uniform fountain?**



ONE energy center DEEPLY underground can do this.

This is dictated by the law of conservation of momentum.

---

**Destruction by a synchronous floor-by-floor implosion of the structure**

... but suddenly the conservation of momentum is violated !

– conservation of the momentum violated, formation of a fountain points to ONE energy center DEEPLY underground

Source 1: <http://911research.wtc7.net/wtc/evidence/photos/wtc1exp21.html>

Source 2: <http://911research.wtc7.net/wtc/evidence/photos/wtc2exp5.html>

### 3 Building 7 – energy evaluation

#### The hot chambers in the rockbed

Building 7 was the third skyscraper which collapsed and turned to dust on 9/11, although it was not hit by an airplane.

Infrared images taken in October 2001 still showed high temperatures from scorching hot steel in the foundation of all three buildings.

What kind of explosive could have stored so much energy in the rock?

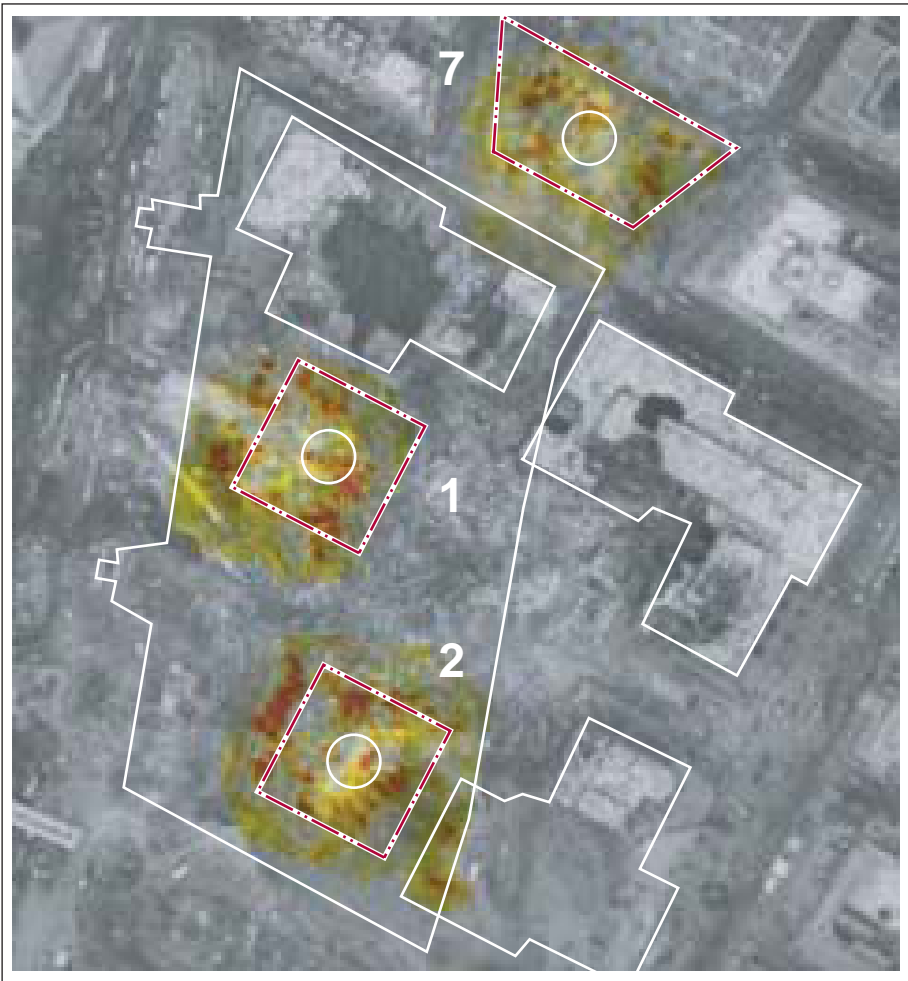

Source: [http://911research.wtc7.net/papers/dreger/GroundZeroHeat2008\\_07\\_10.pdf](http://911research.wtc7.net/papers/dreger/GroundZeroHeat2008_07_10.pdf)

## Energy is measured in joules

When a 1kt nuclear bomb is being detonated it transfers its nuclear energy of 4.184 terajoules into [mostly] thermal energy.

How many Joules are needed to heat up the rock below Building 7?

With a surface of 3,750 m<sup>2</sup>, a cooling time of 4 months and an [estimated] mean start temperature of 300 °C the entire amount stored energy is well within the terajoule-range:  $\sim 10^{12}$  Joule.

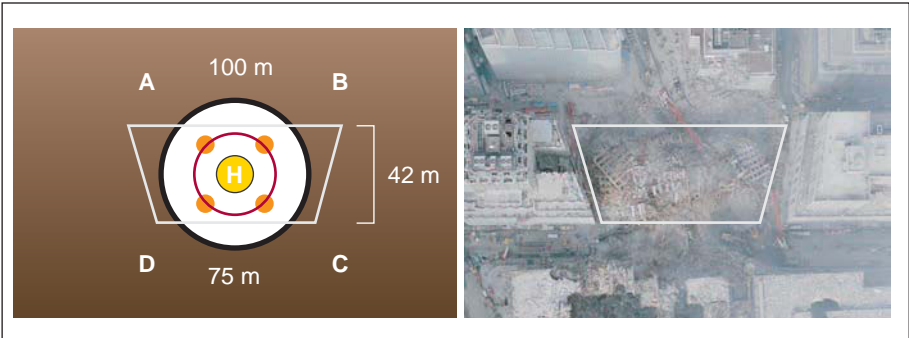

Source (photo): <http://www.noaanews.noaa.gov/wtc/images/wtc-photo.jpg>

## The cooking plate analogon

A typical cooking plate [0.02 m<sup>2</sup>] with 2,000 W reaches its temperature within 20 seconds, thus storing: 2,000 W · 20 s = 40 kJ.

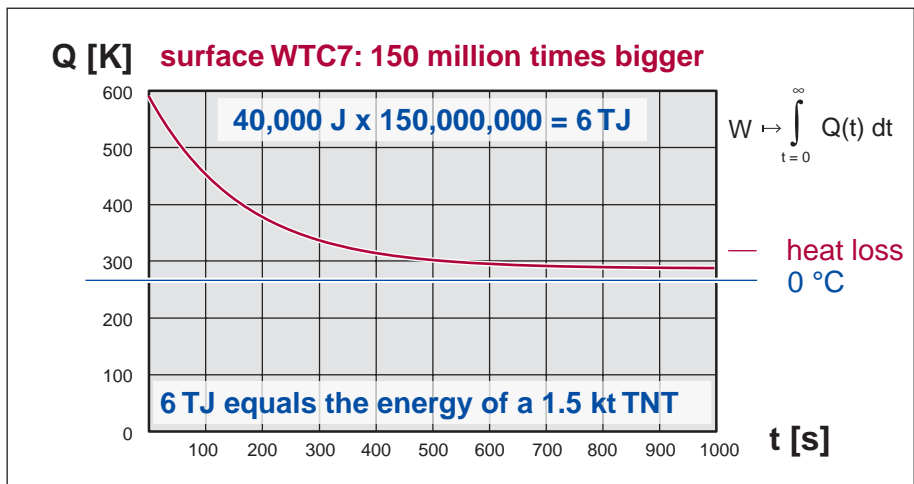

Source: <https://en.wikipedia.org/wiki/Energy>



## 4 Building 7 – the mushroom cloud

Although the free fall collapse of Building 7 has been thoroughly analyzed and discussed, crucial evidence was blocked from view.



Source @06:04: <https://www.youtube.com/watch?v=Ujps2oCA-nU>

The pyroclastic flow of the WTC 7 dust and the hot, violently rising mushroom cloud were never reported or analyzed by "the experts".

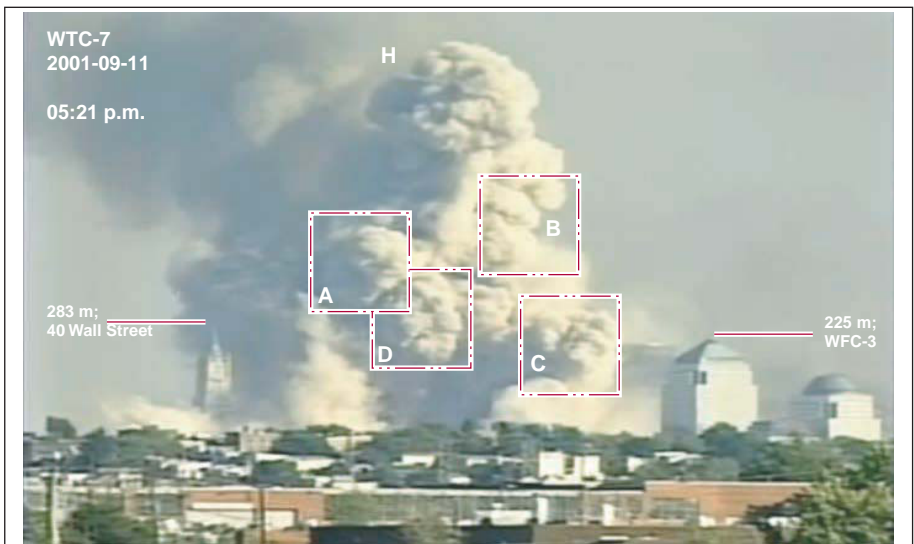

Source @12:33: <http://www.youtube.com/watch?v=JnLcUxV1dPo>



## Vortex formation

The central mushroom cloud rising up from the foundation of Building 7 developed a vortex (tubular form of water vapor).



Source @13:10: <http://www.youtube.com/watch?v=JnLcUxV1dPo>

A vortex can often be observed during a nuclear weapon test.

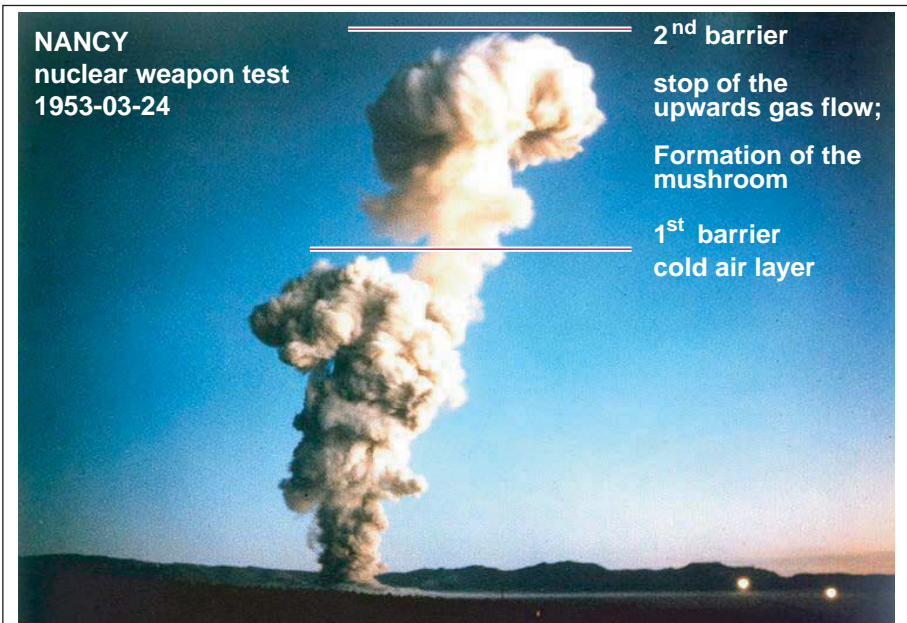

Source: [http://commons.wikimedia.org/wiki/File:Upshot-Knothole\\_Nancy\\_001.jpg](http://commons.wikimedia.org/wiki/File:Upshot-Knothole_Nancy_001.jpg)

# 5 The truth behind the 'Dirty Bomb tale'

During fission uranium-235 will split into a variety of radioactive elements. The decay chain of these elements is well known.

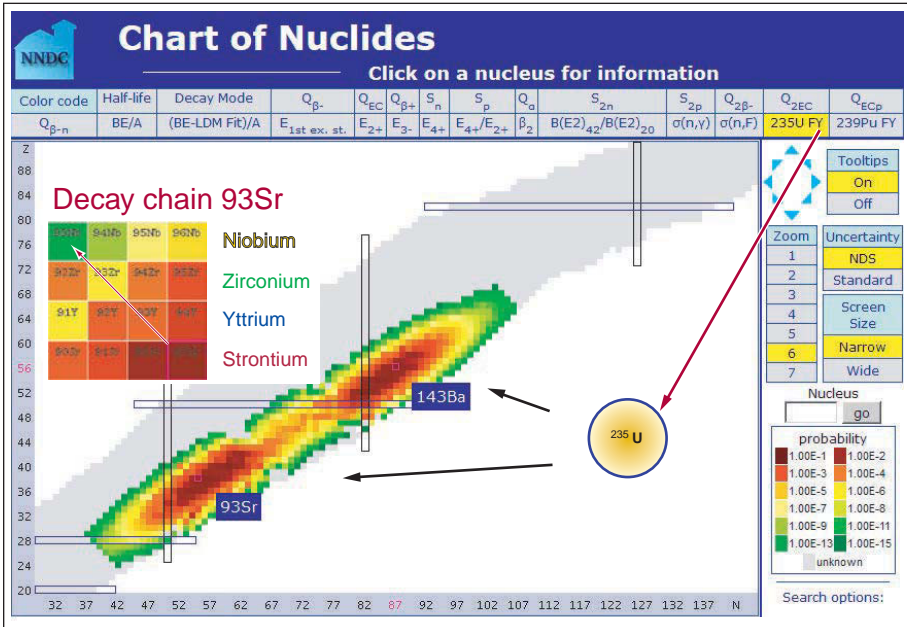

Source: <http://www.nndc.bnl.gov/chart/reCenter.jsp?z=26&n=30>

The presence of these decay elements was confirmed in the USGS dust sample analysis, however without indicating their radioactivity.

USGS Spectroscopy Lab - World Trade Center USGS Leachate Table <http://pubs.usgs.gov/of/2001/ofr-01-0429/leach1/WTCleachtable.html>

**Leach Table 1**

**Decay chain 93Sr**

	Outdoor dust samples				
	WTC-01-2	WTC-01-3	WTC-01-05	WTC-01-06	WTC-01-14
Strontium $\mu\text{g/L}$	834	561	1150	1100	1230
Yttrium $\mu\text{g/L}$	< 0.01	< 0.01	0.08	0.08	0.11
Zinc $\mu\text{g/L}$	10.7	7.7	15.6	20.9	11.6
Zirconium $\mu\text{g/L}$	0.07	0.1	0.5	0.3	0.08
Niobium $\mu\text{g/L}$	< 0.02	0.03	0.1	0.1	0.02

Source: <http://pubs.usgs.gov/of/2001/ofr-01-0429/leach1/WTCleachtable.html>

## The ring of protection

Radioactivity in the subsoil cannot be controlled. However, it is possible to control the flow of information and stop it spreading.

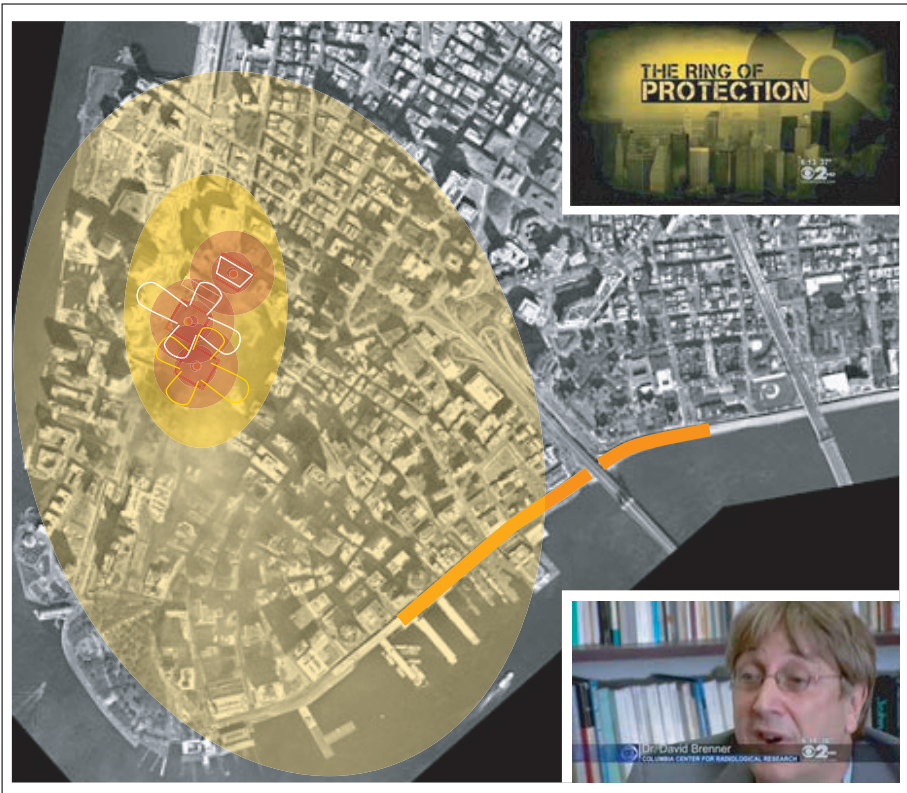

Source 1: <http://www.loc.gov/exhibits/911/images/lg-map-aerial1.jpg>

Source 2: [http://www.nyc.gov/html/nypd/html/pr/pr\\_2011\\_stc\\_exercise\\_april\\_5\\_2011.shtml](http://www.nyc.gov/html/nypd/html/pr/pr_2011_stc_exercise_april_5_2011.shtml)

After 9/11 the "ring of protection" was implemented: a tightly knit net with over 4,000 people ensured that no "false alarms" were reported.

## The Dirty Bomb strategy

"I think its more the question of 'when' than 'whether' we'll have one."

Source: Dr. David Brenner / Columbia Center for Radiological Research

## Camera scintillation: a sign of direct exposure to radioactivity

Reporters' cameras that were directly engulfed in the dustcloud suddenly started recording white dots and flashes.



Source @ 00:45: (FOX News): <https://www.youtube.com/watch?v=uGaiSrxhRhU>

### Cancers



Health • Diet • Fitness • Living Well • Parenting • Family • What Signs

## 5,400 diagnosed with cancers linked to September 11 attacks

By Laura Ly, CNN

Updated 23:42 GMT (05:42 HKT) August 15, 2016



Source: <http://edition.cnn.com/2016/08/15/health/september-11-cancer-diagnoses/index.html>



## Camera fails / Cancers

A short EMP or radiation impulse provoked a camera glitch two times: at zero time and eight seconds after.



Source: @ 00:07: [https://www.youtube.com/watch?v=cz-\\_voimcG8](https://www.youtube.com/watch?v=cz-_voimcG8)

## Cancers

THE SUN, A NEWS UK COMPANY ▾

**THE Sun**  Yiewsley ▾  
Now 21°C | 4pm 22°C

< | TV & SHOWBIZ | **NEWS** | LIVING | MONEY | MOTORS | TRAVEL | TECH

All News | UK News | World News | Politics | Opinion

**THE 9/11 CURSE** Number of cancer cases linked to September 11 attacks **TRIPLES** in less than three years with **5,400** people now suffering from **6,378** variations of the disease

9/11 survivors have been diagnosed with more than 6370 separate cancers since the 2001 attacks

Source: <https://www.thesun.co.uk/news/1614850/>

# 6 Ground Zero: 100 kt Detonation

The North Tower showed a material ejection pattern very similar to the 100 kt nuclear explosion "Storax Sedan", detonated in sandy soil.



Source 1: <http://911research.wtc7.net/wtc/evidence/photos/wtc1exp10.html>

Source 2: [https://en.wikipedia.org/wiki/Sedan\\_\(nuclear\\_test\)](https://en.wikipedia.org/wiki/Sedan_(nuclear_test))

However, a detailed study of the scale shows that the dome created by "Storax Sedan" would have lifted the entire WTC site up.

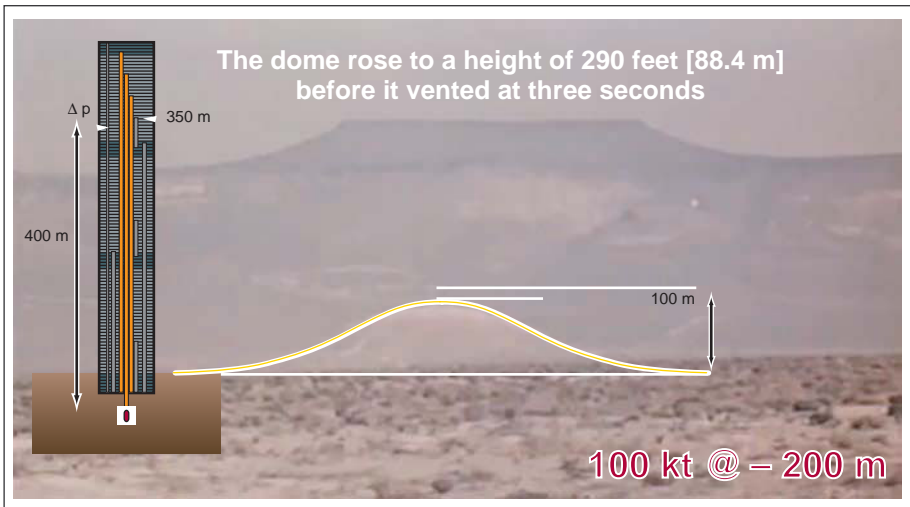

Source @00:02: <https://www.youtube.com/watch?v=dyMegAfUqxs>



# 7 Ground Zero: 1 kt Detonation

The impulse response of the 1 kt nuclear explosion ESS Teapot created a spike, shooting 200 m in the air.

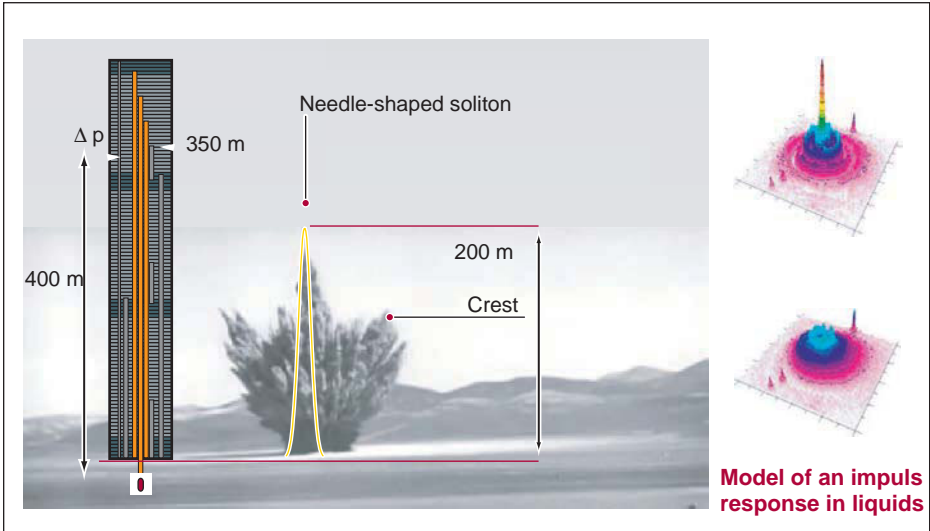

Source 1 @ 00:05: <https://www.youtube.com/watch?v=I9ahoAMAGL8>

Source 2: <http://arxiv.org/abs/1309.3083v1>

Typical for an underground nuclear explosion is the formation of a rising cloud stem, 60 seconds after detonation, due to the hot centre.

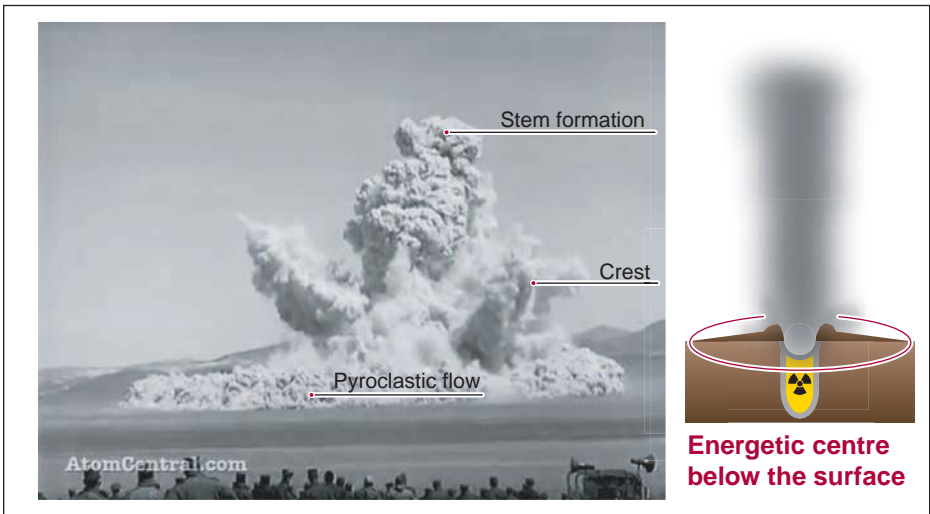

Source @00:50: <https://www.youtube.com/watch?v=I9ahoAMAGL8>



## Melt cavity @ 1 kt yield

In case of a total containment in the hard rockbed [at -50 m] the melt cavity created would had the size of 8 m (plus a weak shockwave).

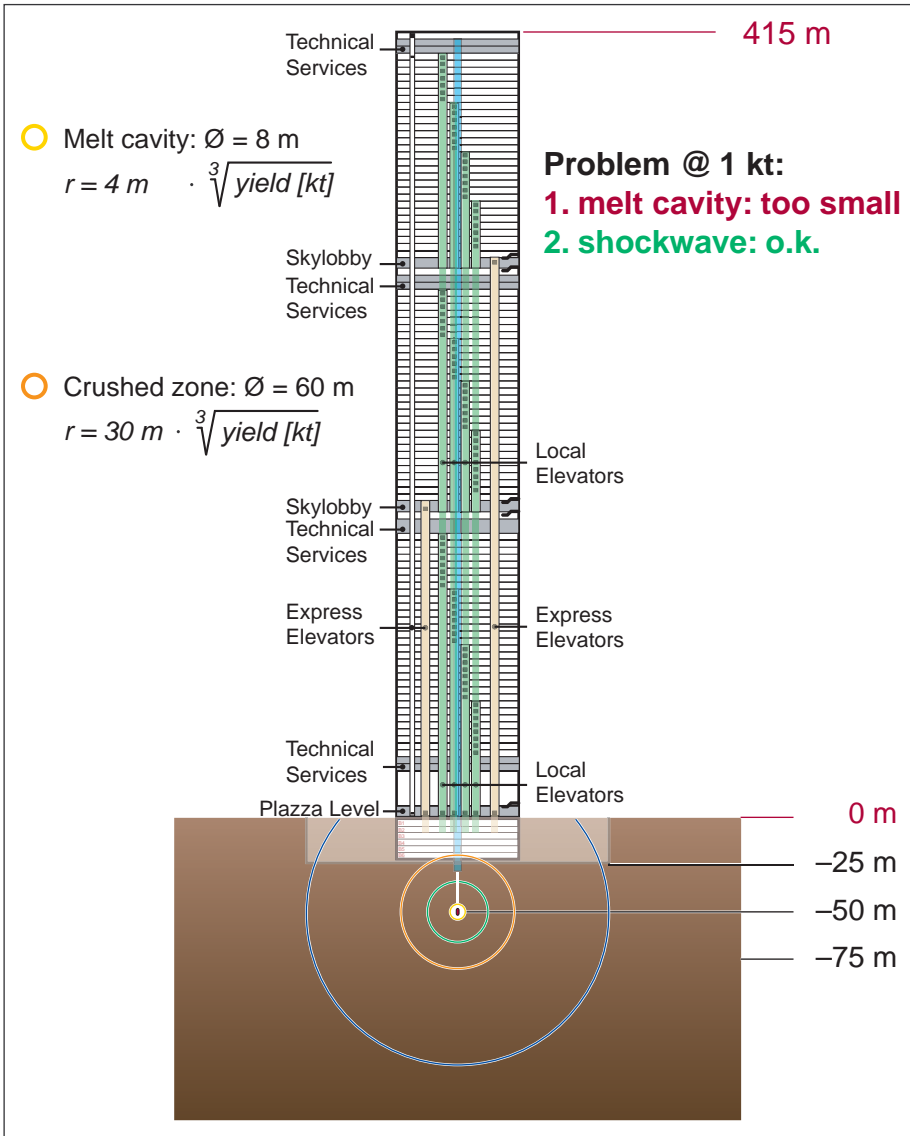

Source [data]: [https://en.wikipedia.org/wiki/Underground\\_nuclear\\_weapons\\_testing](https://en.wikipedia.org/wiki/Underground_nuclear_weapons_testing)

## 8 Pyroclastic density flow

For all three Towers a wave front of a hot solids-gas-dispersion followed the collapse. The South Tower's dust flow was powerful.



Source @16:19: <http://www.youtube.com/watch?v=eEwSHkQvT18>

The North Tower's pyroclastic flow was extreme in its force.



Source @27:06: <http://www.youtube.com/watch?v=eEwSHkQvT18>

## Building 7 and its pyroclastic density flow

For Building 7 extenuated overpressure waves developed that were channelized by the urban canyons.



Source 1 @05:31: <https://www.youtube.com/watch?v=Ujps2oCA-nU>

Source 2 @06:31: <https://www.youtube.com/watch?v=Ujps2oCA-nU>

## The firemens' report

“Then the dust cloud hits us. Then it got real hot. It felt like it was going to light up almost.”

– Thomas Spinard, FDNY Engine 7

“A wave – a hot, solid, black wave of heat threw me down the block.”

– David Handschuh, New York’s Daily News



Source [extract]: [http://www.911history.de/pdfs/Toronto\\_Report\\_p\\_230.pdf](http://www.911history.de/pdfs/Toronto_Report_p_230.pdf)

## THE 9 /11 TORONTO REPORT; Paramedic; Manuel Delgado

“... and then we were engulfed in the smoke, which was horrendous. One thing I remember, it was hot. The smoke was hot and that scared me.”

Source [extract]: [http://www.911history.de/pdfs/Toronto\\_Report\\_p\\_230.pdf](http://www.911history.de/pdfs/Toronto_Report_p_230.pdf)

# 9 The nuclear weapon

It is unlikely that a **first generation** nuclear weapon was used on 9/11, as its efficiency is only 2%, the fallout would have been enormous.



## Chart of Nuclides

Click on a nucleus for information

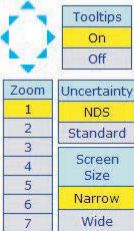
Color code	Half-life	Decay Mode	$Q_{EC}$	$Q_{\beta^+}$	$S_n$	$S_p$	$Q_{\alpha}$	$S_{2n}$	$S_{2p}$	$Q_{2\beta^-}$	$Q_{2EC}$	$Q_{ECp}$	
$Q_{\beta^-}$	BE/A	(BE-LDM Fit)/A	$E_{1st}$	$E_{2+}$	$E_{3-}$	$E_{4+}$	$E_{4+}/E_{2+}$	$\beta_2$	$B(E2)_{42}/B(E2)_{20}$	$\alpha(n,\gamma)$	$\alpha(n,F)$	235U FY	239Pu FY
232U 68.9 Y $\alpha$ : 100.00% SF: 3E-12%	233U 1.592E+5 Y	234U 2.455E+5 Y 0.0064% $\alpha$ : 100.00% SF: 1.6E-9%	235U 7.04E+8 Y 0.7200% $\alpha$ : 100.00% SF: 7.0E-9%	236U 2.342E7 Y	237U 6.75 D	238U 4.468E9 Y 99.274% $\alpha$ : 100.00% SF: 3.5E-9%	239U 23.45 M	240U 14.1 H	238Pu 2.27 M	239Pu 1.8 H			
231Pa 3.276E+4 Y	232Pa 1.3E D	233Pa 26.973 D	235U						238Pa 100 ns	239Pa 1.8 H			
230Th 7.54E+4 Y	231Th 25.53 H	232Th 1.40E10 Y 100%	E(level)	Jn	$T_{1/2}$	Decay Modes			237Th 4.7 M	238Th 9.4 M			
230Th 7.54E+4 Y $\alpha$ : 100.00% SF: 2E-11%	231Th 25.53 H $\beta$ : 100.00% SF: 9E-11%	232Th 1.40E10 Y 100% $\alpha$ : 100.00% SF: 1.1E-9%	0.0	7/2-	7.04E+8 y I	$\alpha$ : 100.00 % SF: 7.0E-9 % $^{26}\text{Mg}$ : 8.E-10 % $^{26}\text{Ne}$ : 8.E-10 %	IT: 100.00 %	$\beta$ : 100.00%	$\beta$ : 100.00%				
230Th 7.54E+4 Y $\alpha$ : 100.00% SF: 2E-11%	231Th 25.53 H $\beta$ : 100.00% SF: 9E-11%	232Th 1.40E10 Y 100% $\alpha$ : 100.00% SF: 1.1E-9%	0.0001	1/2+	$\approx$ 26 m				$\beta$ : 100.00%	$\beta$ : 100.00%			

- **Weight of nuclear fuel: 64 kg,**
- **Blast yield: 16 kt**
- **Bomb weight: 4,400 kg**
- **Length: 3.0 m / Diameter: 0.71 m**
- **Purity fuel type: 80% uranium-235** Pure fission weapon (Hiroshima type)

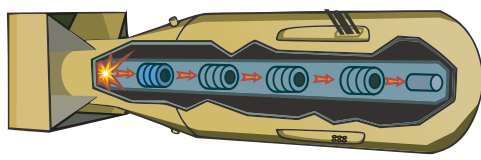

Source 1: <http://www.nndc.bnl.gov/chart/reCenter.jsp?z=92&n=143>  
 Source 2: [https://en.wikipedia.org/wiki/Little\\_Boy](https://en.wikipedia.org/wiki/Little_Boy)

It is also unlikely that a **second generation** nuclear weapon was used, as a simple fission–fusion stage would have created strong neutron radiation and an extremely powerful shockwave ("Khalezov-problem").

fusion hydrogen H-charge

second neutron reflector

first neutron reflector

uranium-235 charge

conventional explosive

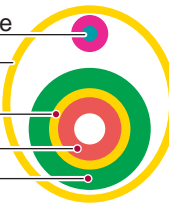

**Fusion stage**

**Fission stage [primary]**

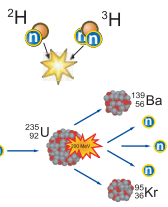



Thermonuclear weapon (Castle Bravo type)

Source 1: [https://en.wikipedia.org/wiki/Nuclear\\_weapon\\_design](https://en.wikipedia.org/wiki/Nuclear_weapon_design)  
 Source 2: [https://en.wikipedia.org/wiki/Castle\\_Bravo](https://en.wikipedia.org/wiki/Castle_Bravo)

## X-ray slow fusion shape charge

However, a **third generation** nuclear weapon type uses:

- artificial sources of neutron radiation, minimizing critical mass / fallout
- strong neutron reflectors, thus further minimizing critical mass
- strong neutron absorbers, preventing neutron activation [MRR]
- shape charge for influencing the direction of the energy [DEW]
- strong X-ray emission by neutron scattering elements
- nuclear fizzle / slow fusion for a long burn (underground)
- neutron collimator tunnel (if the charge is buried underground)

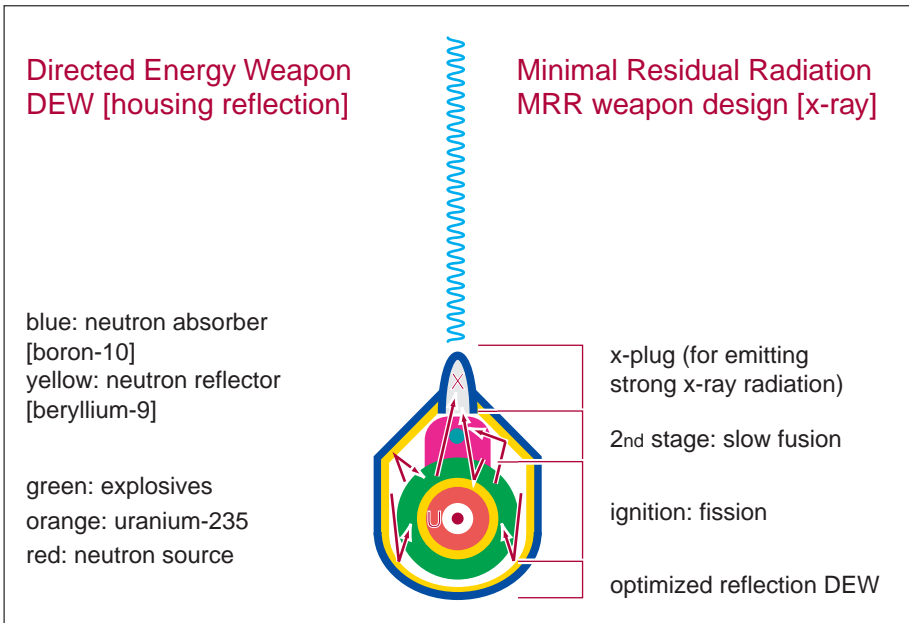

Source [modified]: <https://arxiv.org/pdf/physics/0510071>

- These characteristics make the third generation nuclear weapon the prime suspect for being used on 9/11.

## NOTE

Fission-free **fourth generation** nuclear weapons do exist only on a laboratory scale (anti-matter, pure directed nuclear plasma, etc.).



# 10 The weapon's effect on the Bathtub

The Bathtub protected the WTC from underground waters.

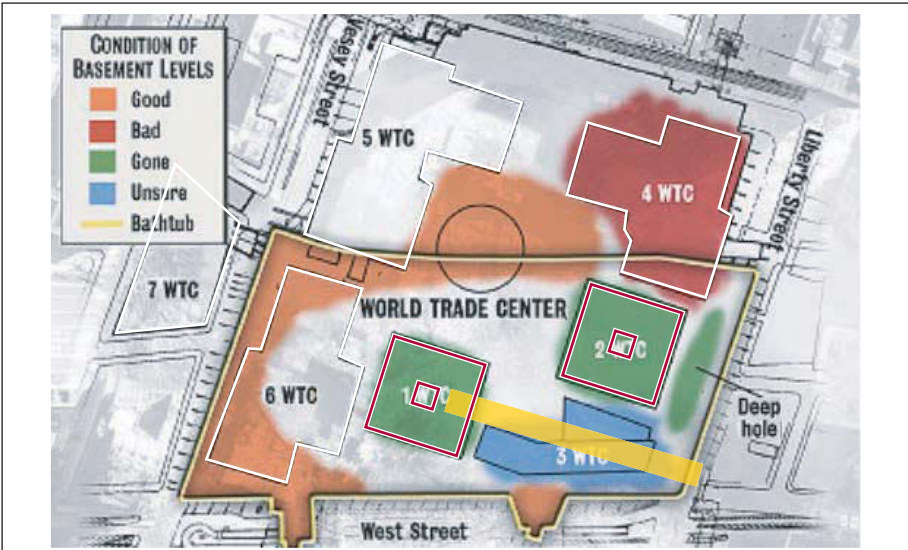

<http://www.veteranstoday.com/2013/09/02/nuclear-demolition-of-the-world-trade-center-damage-to-bathtub/>

Picture of the cleaned “Bathtub” on September 11, 2002



Source: <https://cbskymx2.files.wordpress.com/2011/09/1641793.jpg>

Large melting pots of formerly liquefied granite were found on site.



Source: <http://themillenniumreport.com/wp-content/uploads/2014/09/2j1k8wi.jpg>

Partly these rocks were broken up and carried away.

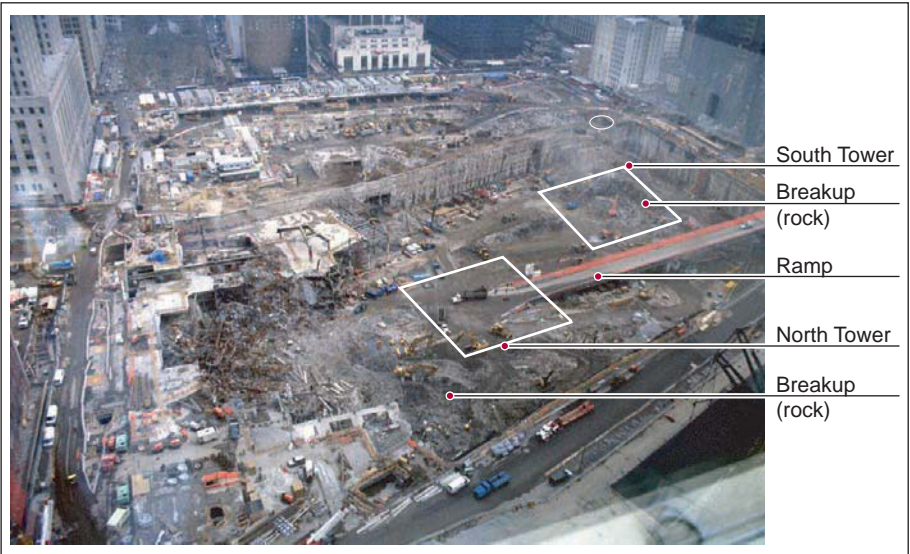

Source: <http://drjudywood.com/articles/DEW/StarWarsBeam1.html>



Concrete was pumped into the fissures to seal the caverns.

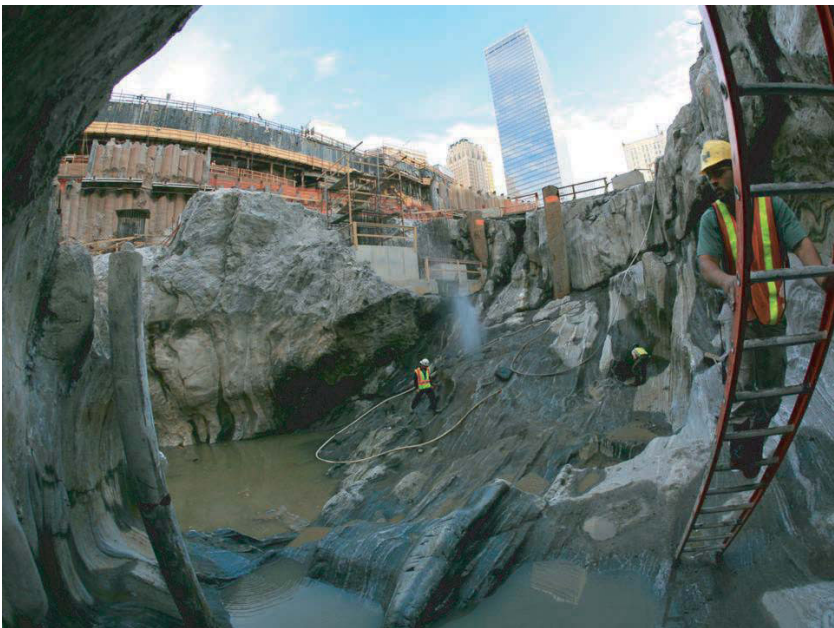

Source: <https://www.facebook.com/911JusticeHalifax/photos/a.432251866796271.92952.362933107061481/432252346796223/>



## Creation of the Bathtub caverns

- release of shockwave and neutron / x-ray flash [ignition, fission]
- cavity sealed off, slow fusion and strong x-ray emission upwards

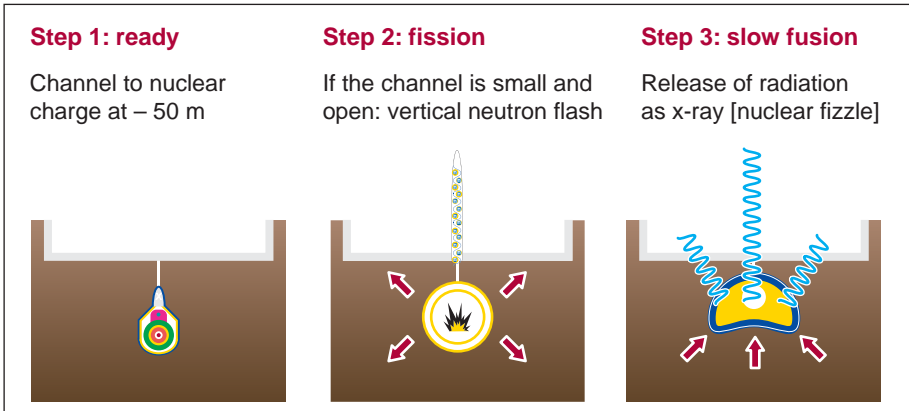

Dimitri Khalezov (modified): <https://wikispooks.com/wiki/File:SkyScraperScheme.jpg>

Vitrified rock structures of a result of radiation and the eruption.



Source: <https://www.facebook.com/911JusticeHalifax/photos/a.432251866796271.92952.362933107061481/432252346796223/>

# 11 The weapon's effect on the Twin Towers

## 11.1 Seismic shock

### South Tower

The seismic shockwave was registered with:

- signal magnitude = 2.1
- signal duration = 10 seconds

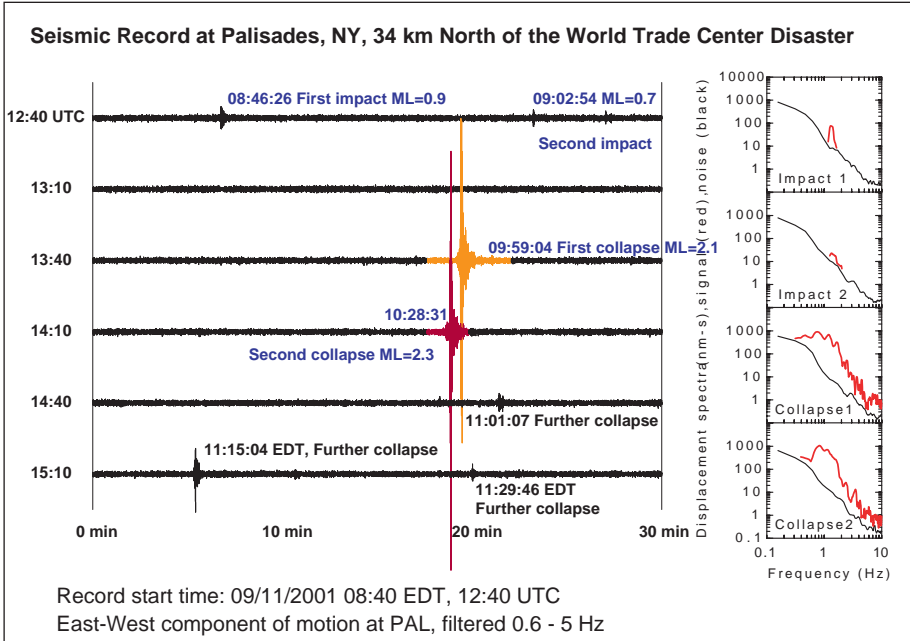

Source: [http://www.ideo.columbia.edu/LCSN/Eq20010911\\_WTC/WTC\\_LDEO\\_KIM.pdf](http://www.ideo.columbia.edu/LCSN/Eq20010911_WTC/WTC_LDEO_KIM.pdf)

Registered signals at Palisades from impacts and collapses:

Date	Origin Time (UTC)	Magnitude (Richter scale)	Time (EDT)	Dominant Period	Signal Duration	Remark
09/11/2001	12:46:26±1	0.9	08:46:26	0.8 sec	12 seconds	first impact
09/11/2001	13:02:54±2	0.7	09:02:54	0.6 sec	6 seconds	second impact
09/11/2001	13:59:04±1	2.1	09:59:04	0.8 sec	10 seconds	first collapse
09/11/2001	14:28:31±1	2.3	10:28:31	0.9 sec	8 seconds	second collapse
09/11/2001	21:20:33±2	0.6	17:20:33	0.7 sec	18 seconds	Building 7 collapse

Source: <http://911truthout.blogspot.de/2017/04/more-hints-of-bigger-than-reported-911.html>

## North Tower

The seismic shockwave was registered with:

- signal magnitude = 2.3
- signal duration = 8 seconds

---

### Important: a delay of 9 seconds between shockwave and eruption



While the burning North Tower was being filmed, the camera's tripod suddenly quivered.

Nine seconds later the North Tower fell.

Sofia Smallstorm  
911 Mysteries  
Demolitions



“ Watch the camera shake on its tripod as a large energy source rocks the ground. Nine seconds later, the North Tower falls. ”



Source @34:24: [https://www.youtube.com/watch?v=3tuAcRur\\_fA](https://www.youtube.com/watch?v=3tuAcRur_fA)

## 11.2 The melting top / disappearing momentum

### South Tower

When the South Tower collapsed, its top started to rotate in free fall, then it stopped suddenly at an inclination angle of approx.  $15^\circ$ .

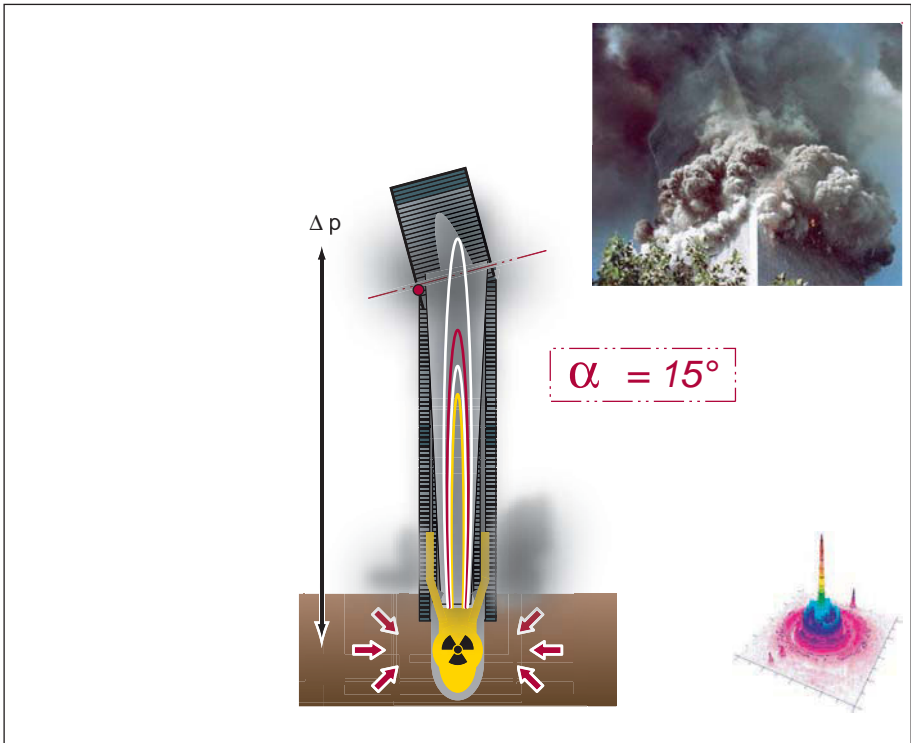

Source 1: <http://911research.wtc7.net/wtc/evidence/photos/wtc2exp4.html>

Source 2: <http://arxiv.org/abs/1309.3083v1>

The weapon triggered the formation of a standing soliton (a superhot plasmic needle) that:

- acted as locking bolt
- melted/dissolved the building's top

## North Tower

When the North Tower collapsed its antenna sank in first, then the top dissolved in free fall, swinging back and forth

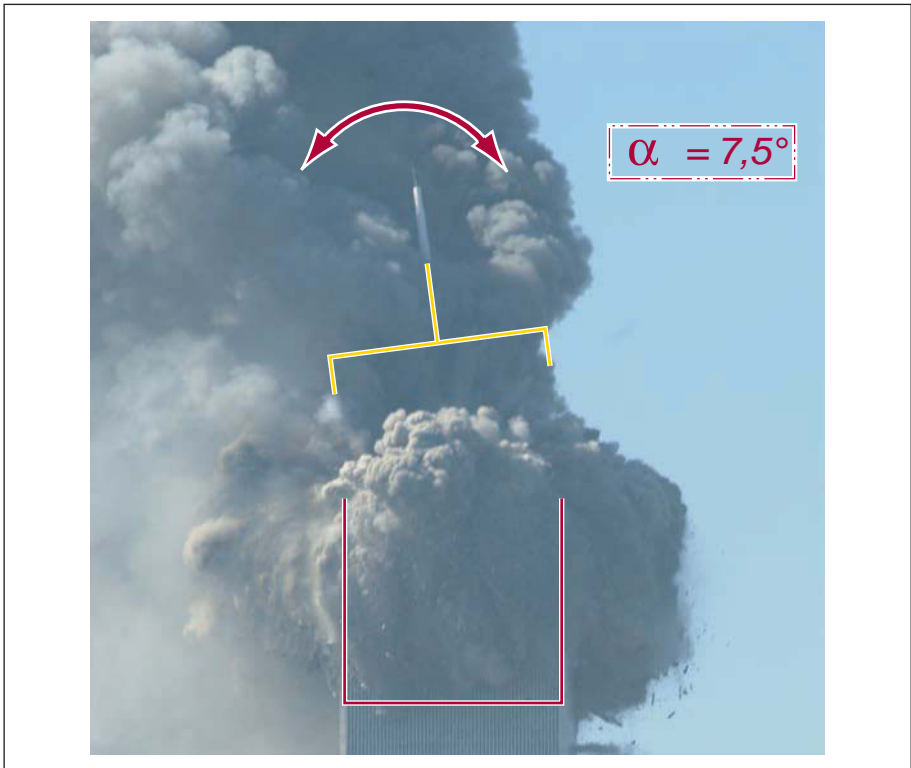

Source: [http://911research.wtc7.net/wtc/evidence/photos/docs/murray/dsc\\_4982.jpg](http://911research.wtc7.net/wtc/evidence/photos/docs/murray/dsc_4982.jpg)

Video source: <https://www.youtube.com/watch?v=IKYW89xEYg0>

The standing soliton is the stabilizing element:

- the tower's top is forced back into a **balanced position**
- while the top is being pulverized from below by the nuclear plasma

## 11.3 Mushrooming and simultaneous escaping of steam at the foundation

### South Tower

The Tower was destroyed as a standing structure from top down, mushrooming on top while steam developed at its foundations.



Source: <http://911research.wtc7.net/wtc/evidence/photos/wtc2exp4.html>

## North Tower

The tower showed the same destruction pattern as the South Tower.

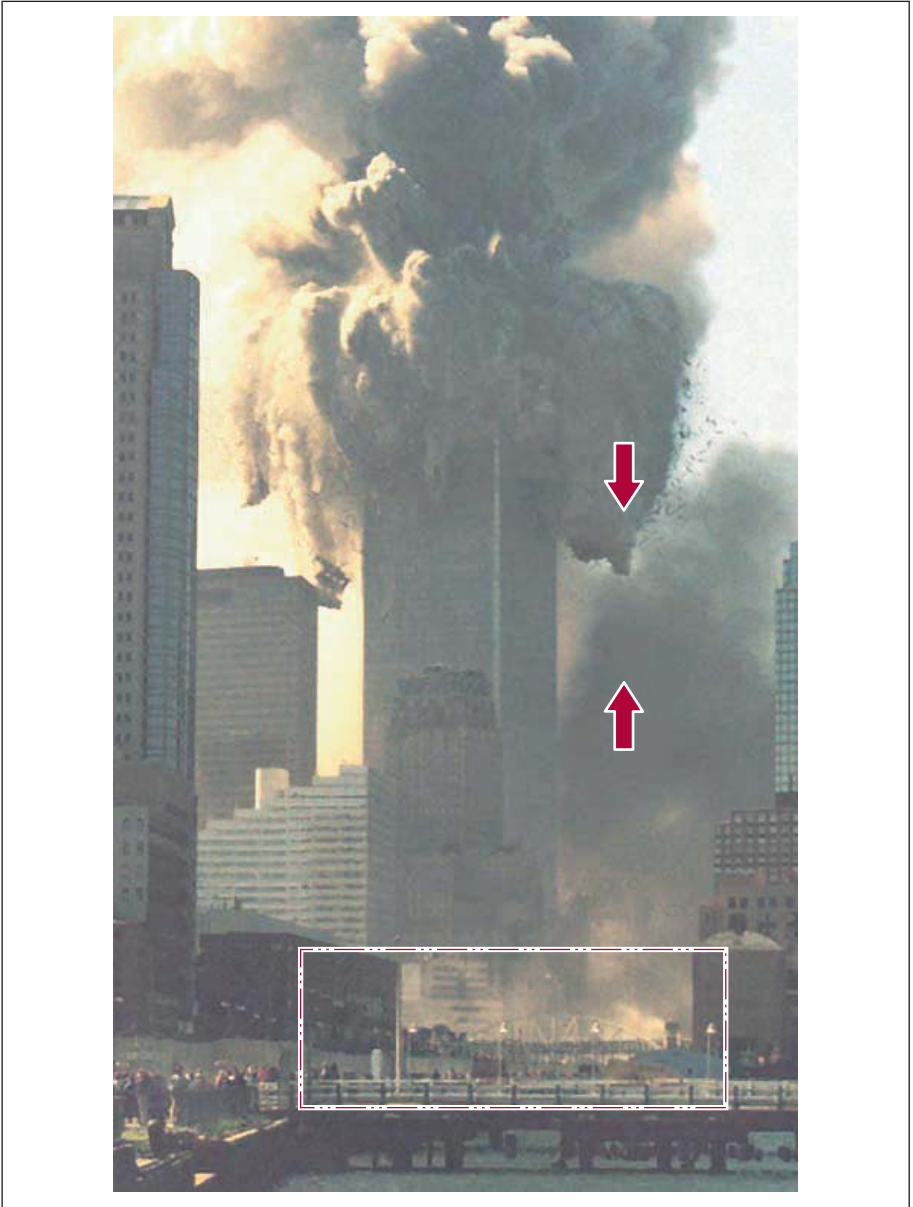

Source: <http://911research.wtc7.net/wtc/evidence/photos/wtc1n1.html>



## 11.4 Steam explosions of the facade

### South Tower

During the disintegration, explosions shooting out of the facade far below the line of destruction could be observed.

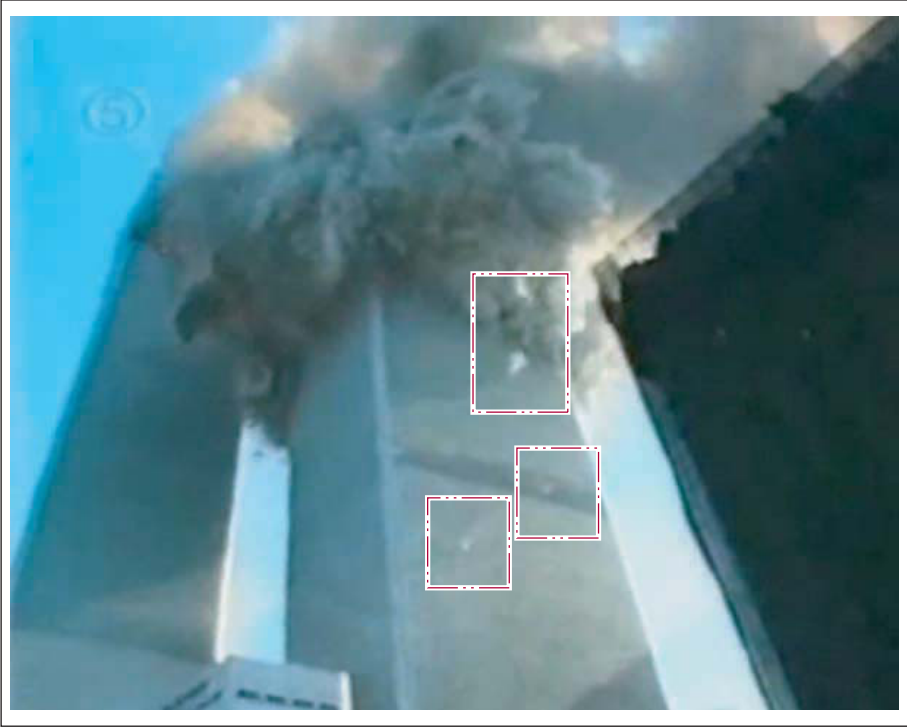

Source @00:04: [http://www.youtube.com/watch?v=k\\_64RigP1Fk](http://www.youtube.com/watch?v=k_64RigP1Fk)

Steam explosions occur when:

- the needle-shaped superhot soliton of nuclear plasma is slightly deviated and touches the concrete walls

Water within the concrete evaporates and acts as a micro-explosive, when suddenly being heated up to over 1,000 °C.



## North Tower

The tower showed the same destruction pattern as the South Tower.

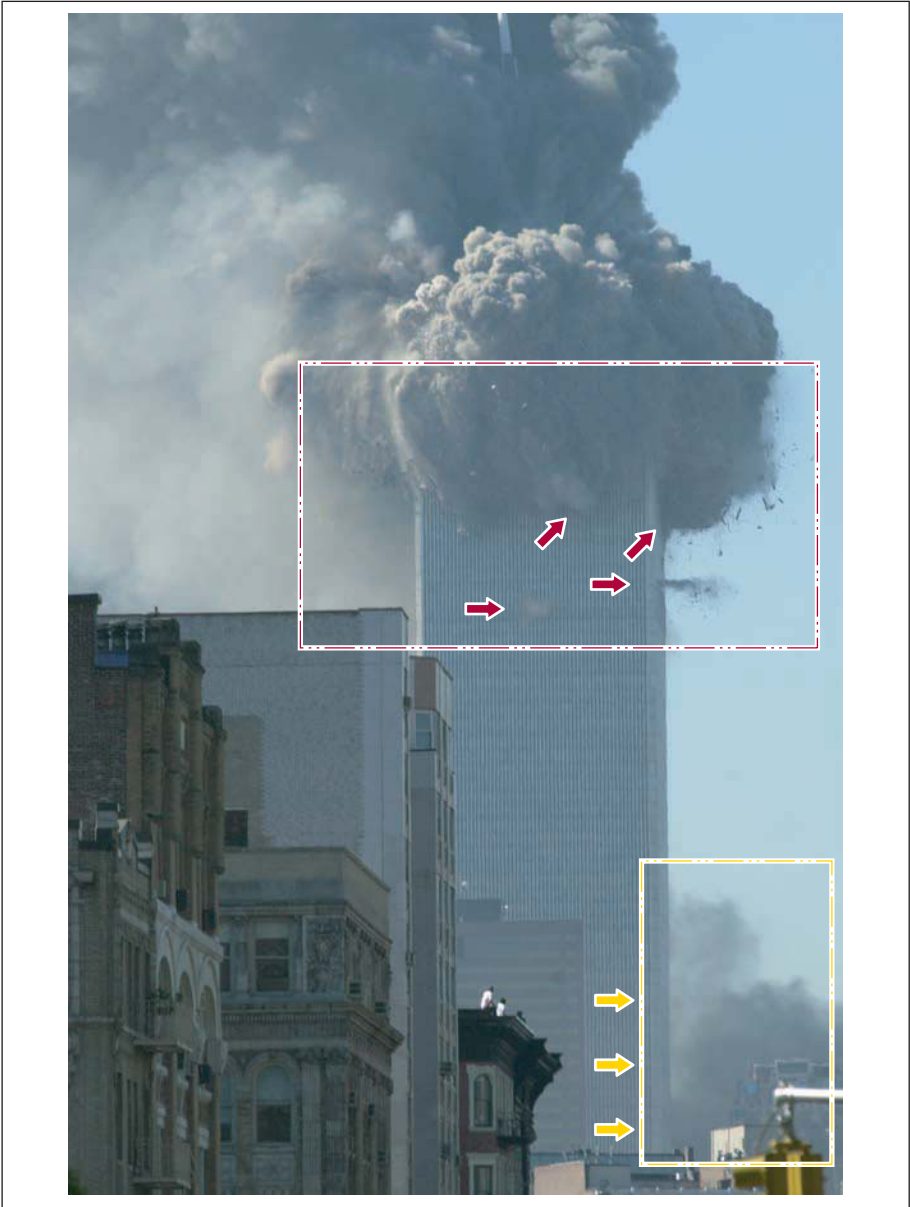

Source: <http://911research.wtc7.net/wtc/evidence/photos/wtc1exp21.html>

## 11.5 Eruption behavior

### South Tower

An eruption-like behavior could obviously be observed for the South Tower.

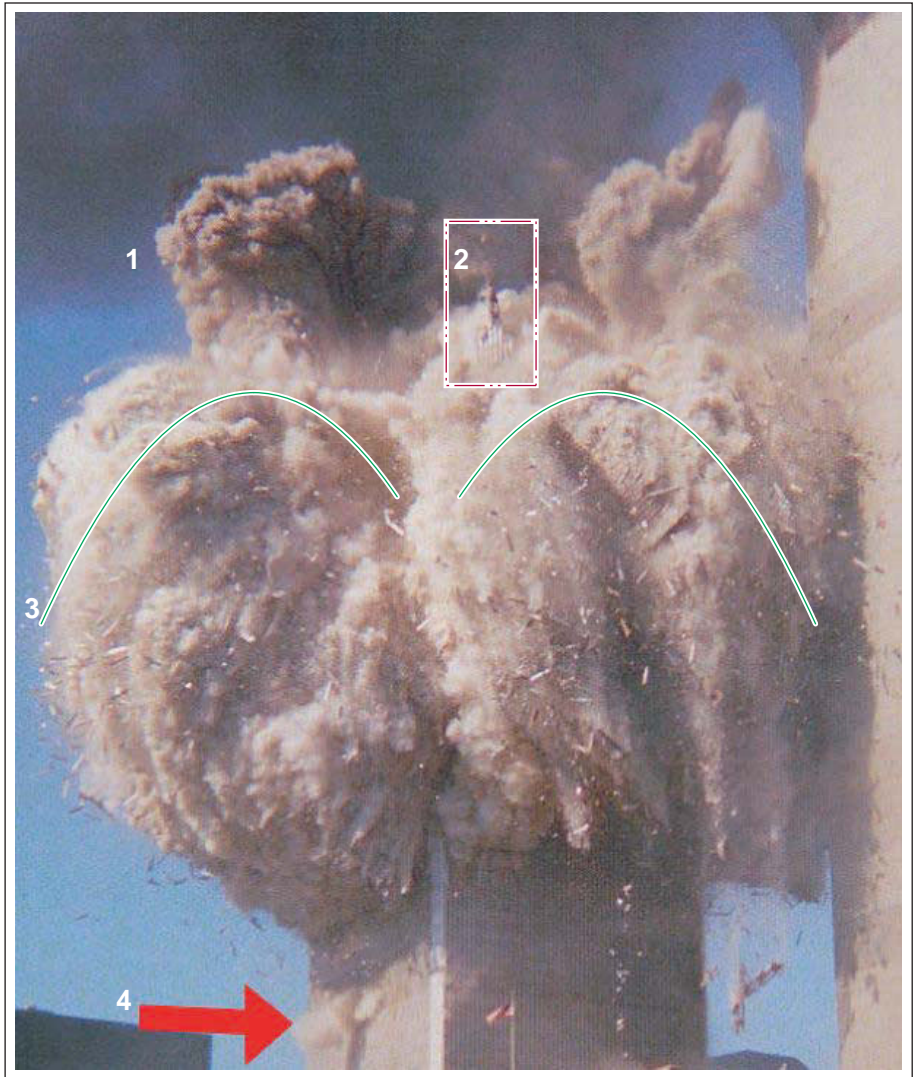

Source: <http://911research.wtc7.net/wtc/evidence/photos/wtc2exp2.html>

1. Black central cloud (core of the building)

3. Ejected material

2. Building structure still intact

4. Steam explosion of the facade

# North Tower

The tower showed the same destruction pattern as the South Tower.

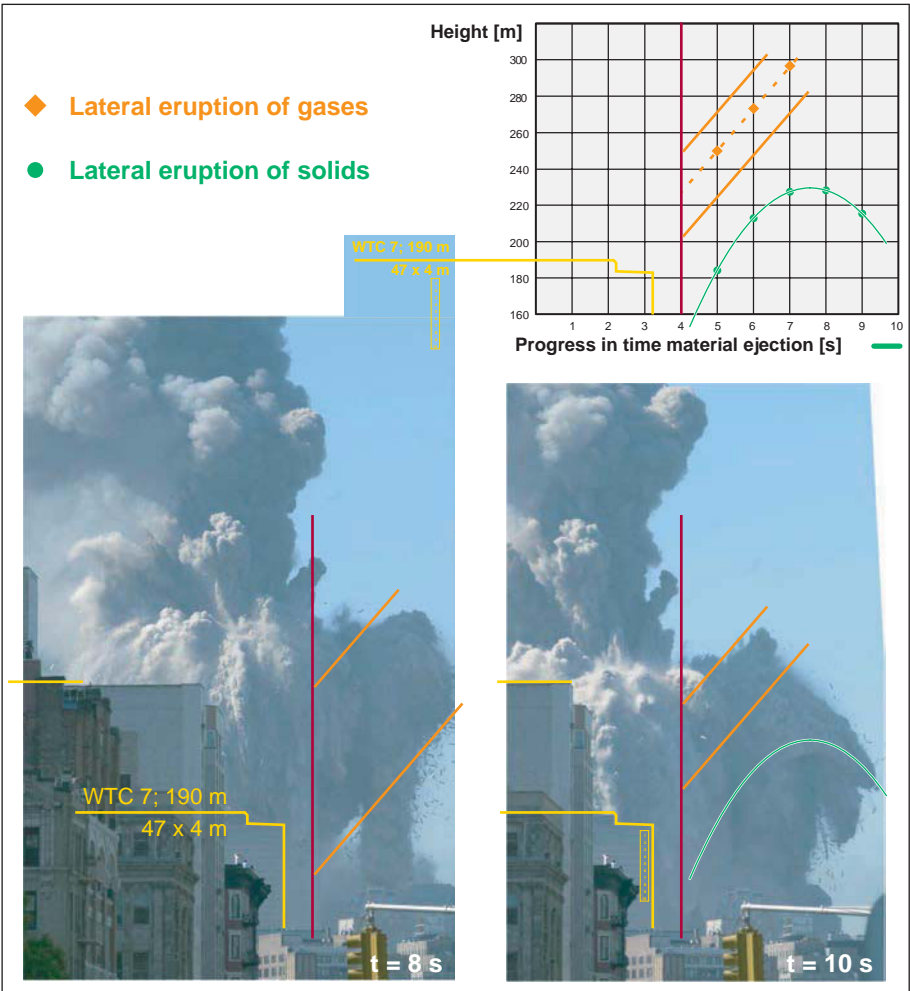

Source: <http://911research.wtc7.net/wtc/evidence/photos/wtc1exp21.html>

- a clearly pronounced **parabola formation** of the ejected material could be observed

## 11.6 Formation of zones

### South Tower

During its disintegration, a clear separation between two different types of dust clouds was observed at the South Tower.

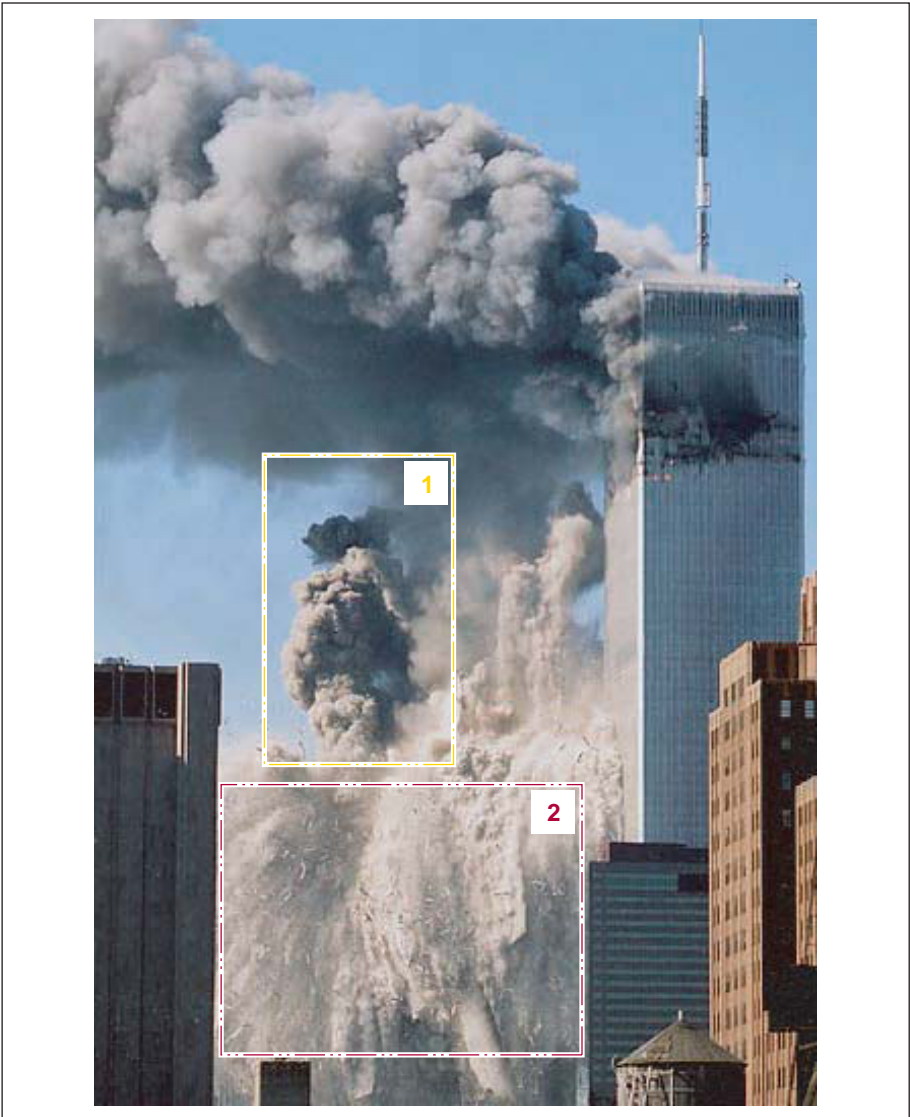

Source: <http://911research.wtc7.net/wtc/evidence/photos/collapses.html>

1. Vaporized steel (black)

2. Pulverized facade (white)

## North Tower

The tower showed the same destruction pattern as the South Tower.

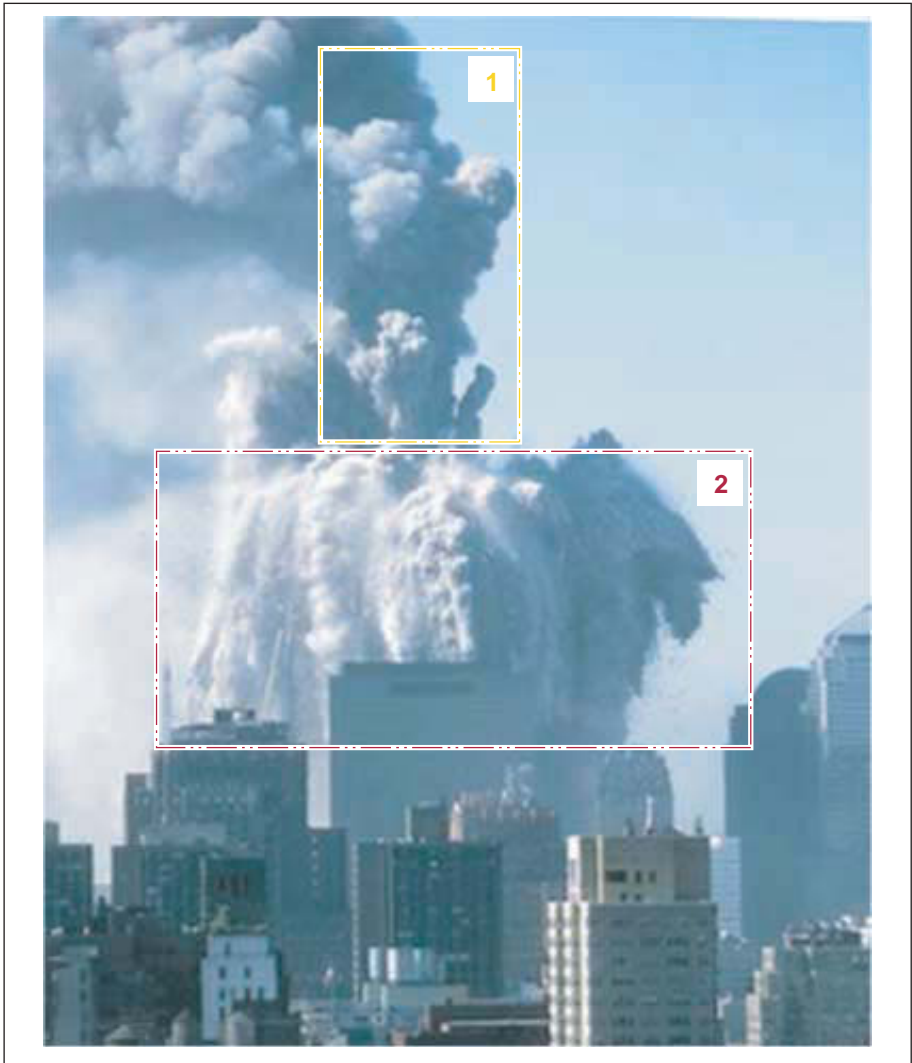

Source: <http://911research.wtc7.net/wtc/evidence/photos/wtc1exp6.html>

1. Vaporized steel (black)

2. Pulverized facade (white)



## 11.7 Fountain formation / sound of a geyser

### South Tower

The disintegration pattern resembled a water fountain.

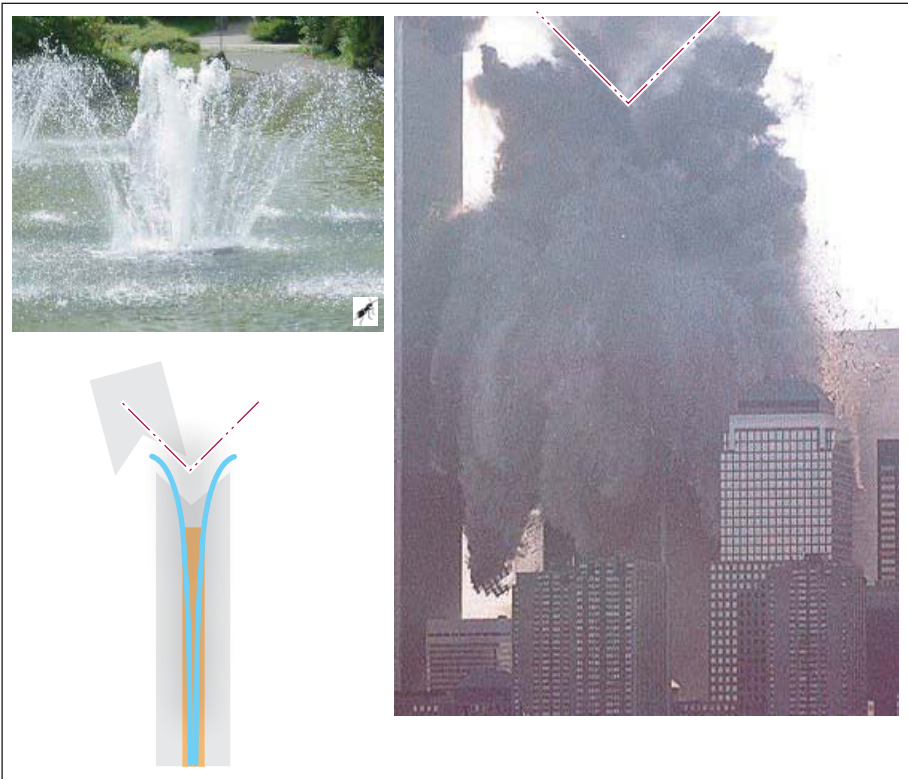

Source 1: <http://www.ju-greber.de/MUC-Springbrunnen03-40.html> 1

Source 2: <http://911research.wtc7.net/wtc/evidence/photos/wtc2exp12.html>

The physical law of **conservation of momentum** states:

- a water jet exiting the nozzle of a fountain keeps its direction
- a gas/material jet exiting the ground also keeps its direction without bursting at the base



## North Tower

The tower showed the same destruction pattern as the South Tower.

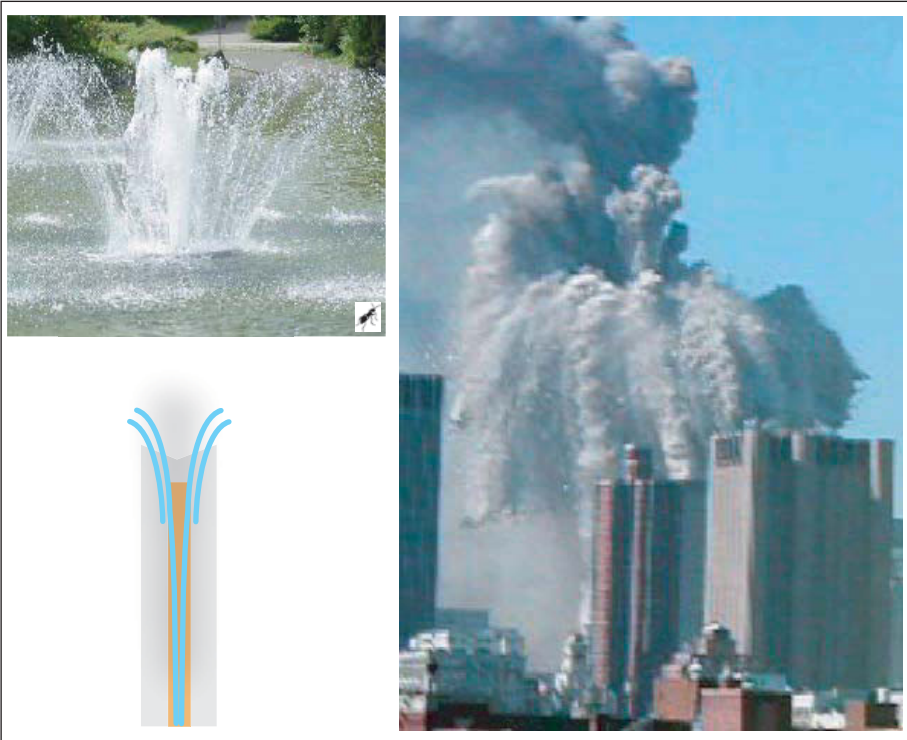

Source 1: <http://www.ju-greber.de/MUC-Springbrunnen03-40.html>

Source 2: [http://911research.wtc7.net/wtc/evidence/videos/nt\\_east.html](http://911research.wtc7.net/wtc/evidence/videos/nt_east.html)

In addition to this fountain an audible effect took place:

- a **howling sound like an erupting geyser** was heard, due to the gas outbursts out of the ground and through the towers

Source 1 @ 00:02 ((Sound WTC 2): [https://www.youtube.com/watch?v=k\\_64RigP1Fk](https://www.youtube.com/watch?v=k_64RigP1Fk)

Source 2 @ 00:07 (Sound WTC 1): <https://www.youtube.com/watch?v=UUofuu36hag>

## 11.8 Gas eruptions from the ground, pressure compensation and updrafts

### South Tower

Out from the ground a powerful eruption of white steam occurred.



Source 1 @ 09:53: [https://www.youtube.com/watch?v=k\\_64RigP1Fk](https://www.youtube.com/watch?v=k_64RigP1Fk)

Source 2 @ 02:27: [https://www.youtube.com/watch?v=cKtHOVyB4\\_8](https://www.youtube.com/watch?v=cKtHOVyB4_8)

## North Tower

Survivors inside the North Tower reported powerful winds, lifting them up – even allowing them to float in the air during a fall.

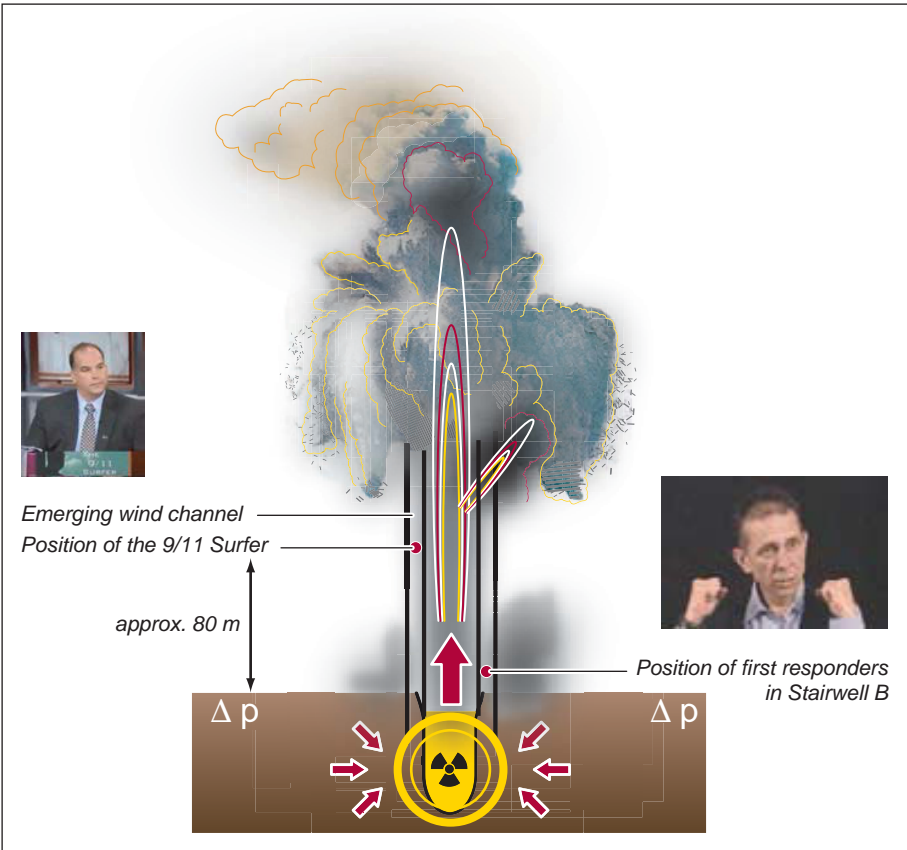

Source 1 @3:25: [https://www.youtube.com/watch?v=yI7\\_ftokN6M](https://www.youtube.com/watch?v=yI7_ftokN6M)

Source 2 @8:12: <https://www.youtube.com/watch?v=9byu31dNQ3k>

### Pasquale Buzzelli (after his free fall from the 22<sup>nd</sup> floor)

“I landed on a pile of rubble, approximately 7 stories high.”

### Firefighter Mickey Kross (Stairwell B)

“It was like a 100-mile-per-hour hurricane.”

## 11.9 Formation of the 'Spire'

### South Tower

Structures close to the ground remained standing for a couple of seconds before collapsing. These structures were nicknamed 'Spire'.



Source 1: @ 08:06: [http://www.youtube.com/watch?v=k\\_64RigP1Fk](http://www.youtube.com/watch?v=k_64RigP1Fk)

Source 2: [http://upload.wikimedia.org/wikipedia/commons/f/f7/WTC-remnant\\_highres.jpg](http://upload.wikimedia.org/wikipedia/commons/f/f7/WTC-remnant_highres.jpg)

## North Tower

The ‘Spire’ of the North Tower rose 200 m high, standing for about twelve seconds before collapsing in a dust cloud.



Source: @ 01:19:28: <https://www.youtube.com/watch?v=zcYfyKnjuD8>

Video: @ 00:16: <https://www.youtube.com/watch?v=DUqTG9LKzJ4>

- The “shot from the foundation” caused the characteristic formation of the residual structures.

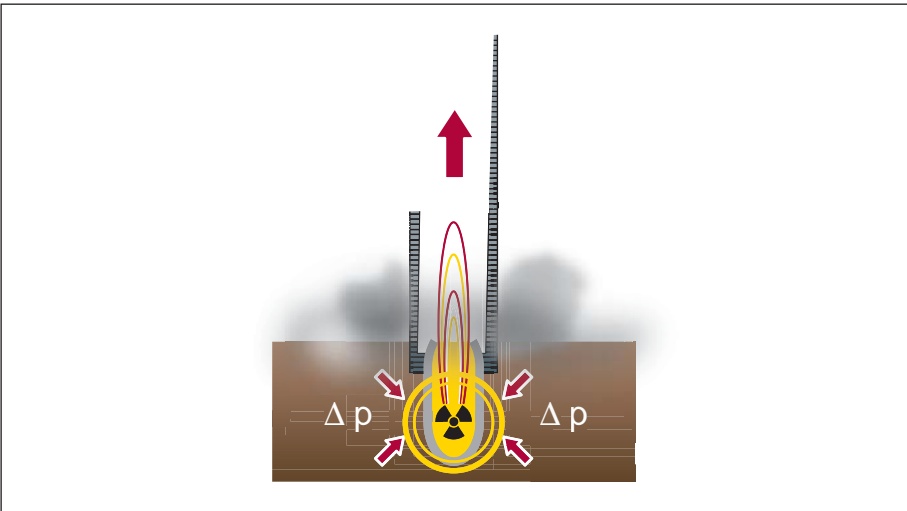

Source (modified): <http://en.wikipedia.org/wiki/File:Nuclear-demolition-damages.jpg>



## 11.10 Standing cloud stem

### South Tower

A rising cloud stem could be observed standing over the cauldron.

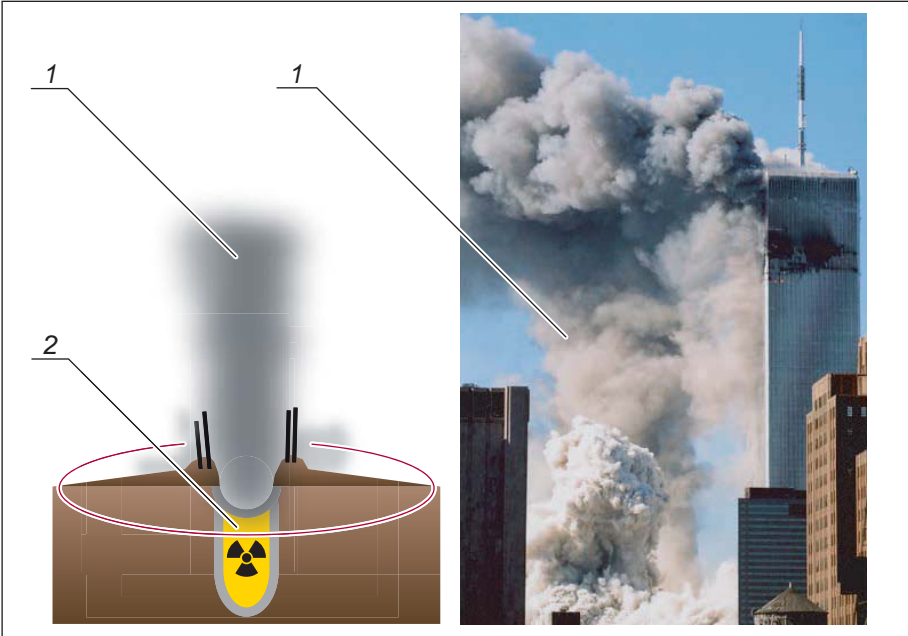

Source (photo): <http://911research.wtc7.net/wtc/evidence/photos/wtc2exp1.html>

1. Nuclear cloud stem

2. Energetic center



Source: <http://911research.wtc7.net/wtc/evidence/photos/wtc2exp12.html>



## North Tower

A distinctive cloud stem was observed over the North Tower's cauldron, which was stable for about one minute.



Source 1: <http://911research.wtc7.net/wtc/evidence/photos/collapses.html>

Source 2: [http://commons.wikimedia.org/wiki/File:Upshot-Knothole\\_Nancy\\_001.jpg](http://commons.wikimedia.org/wiki/File:Upshot-Knothole_Nancy_001.jpg)

Cloud stem formation is typical for an underground nuclear explosion:

- due to the hot centre from below the cloud develops several seconds after detonation

# 12 The weapon's effect on Building 7

## 12.1 Seismic activity

The seismic shockwave – weaker but longer – was registered with:

- signal magnitude = 0.6 ML
- signal duration = 18 seconds

Source: <http://911truthout.blogspot.de/2017/04/more-hints-of-bigger-then-reported-911.html>

## 12.2 Gutting the core out and free fall speed

A few seconds before collapse the buildings's top cap caved in. Then building 7 collapsed in free fall and disappeared in a dustcloud.

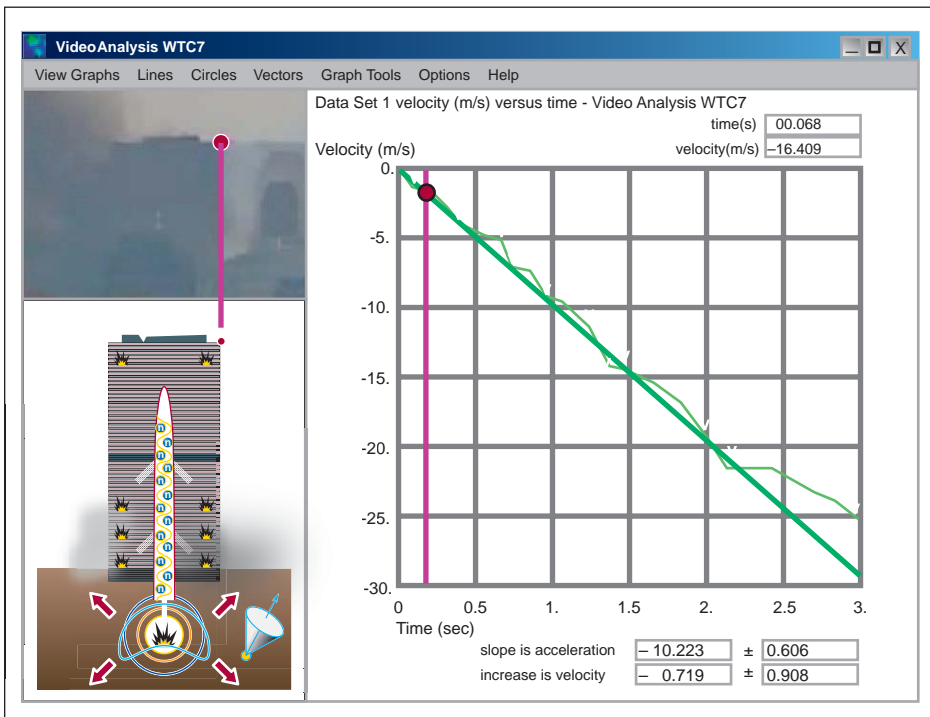

Source 1 @ 06:50: <https://www.youtube.com/watch?v=rP9Qp5QWRMQ>

Source 2 (modified): <http://en.wikipedia.org/wiki/File:Nuclear-demolition-damages.jpg>

## 12.3 The mushroom cloud

One minute after the collapse a mushroom cloud rose into the sky.



Source @ 04:28: <https://www.youtube.com/watch?v=U8lrTy5mrZY>

## 12.4 The rubble pile

The weapon transformed a 190 m high-rise into a small, smoking pile.

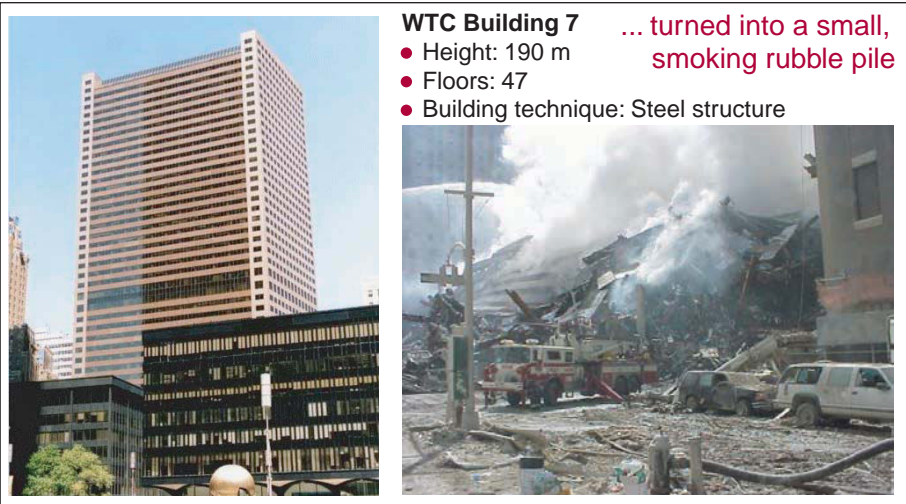

### WTC Building 7

- Height: 190 m
- Floors: 47
- Building technique: Steel structure

... turned into a small, smoking rubble pile

Source 1: <http://911research.wtc7.net/wtc/evidence/photos/wtc7.html>

Source 2: [https://www.facebook.com/911nucleardemolition/photos\\_stream?tab=photos\\_stream](https://www.facebook.com/911nucleardemolition/photos_stream?tab=photos_stream)

# 13 The physical model of destruction

The Twin Towers were constructed as airtight, closed buildings.

Their destruction was achieved by evaporating the inner steel core, using a superhot nuclear plasmatic needle and x-ray radiation.

## 13.1 The need for the nuclear chimney

To allow the nuclear plasma to shoot through the building and to evaporate the inner steel core two factors must be fulfilled:

- the building must be opened on top (for pressure equalization)
- the elevator shafts must be connected, forming one big chimney

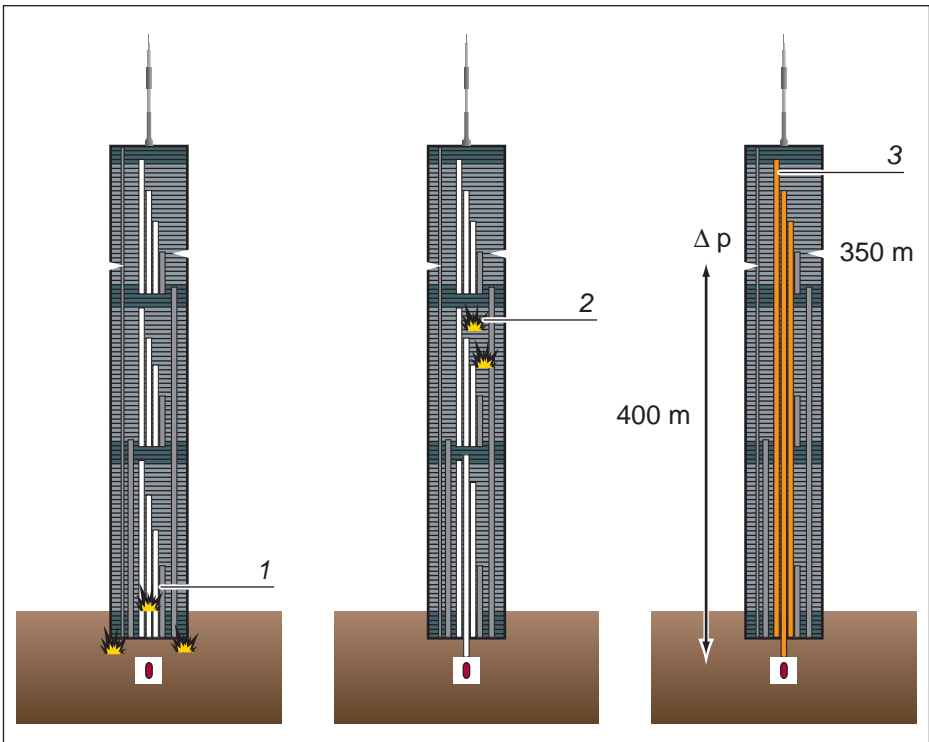

Source (modified): [https://en.wikipedia.org/wiki/World\\_Trade\\_Center\\_\(1973-2001\)](https://en.wikipedia.org/wiki/World_Trade_Center_(1973-2001))

1. Detonations in the lobby / parking level
2. Detonation of the mezzanines

3. Elevator shafts are now connected, connection to the nuclear device exists

## 13.2 Creating the nuclear chimney

The nuclear chimney was created:

- by opening the building on top [by airplanes and explosives]
- by explosions in the sub-basement, leading to the device
- by targeted blasts at the floors to connect the elevator shafts

Seven seconds **before the plane hit the North Tower**, a powerful explosion inside the freight elevator shafts destroyed the lobby.



Source 1 @ 00:07: <https://www.youtube.com/watch?v=4zOhn-sWrUk>

Source 2 @ 01:09: <https://www.youtube.com/watch?v=XvUIQZ7t7Ak>

### 13.3 Weakening of the structure [pre-collapse]

The weakening of the structure was achieved by:

- detonating cutter-charges at the core steel columns
- using the incendiary thermite for creating brief bursts of high temperature in small areas (partial melt out)

Little fountains of liquid metal, similar to discharges or little detonations were ejected from the facade.

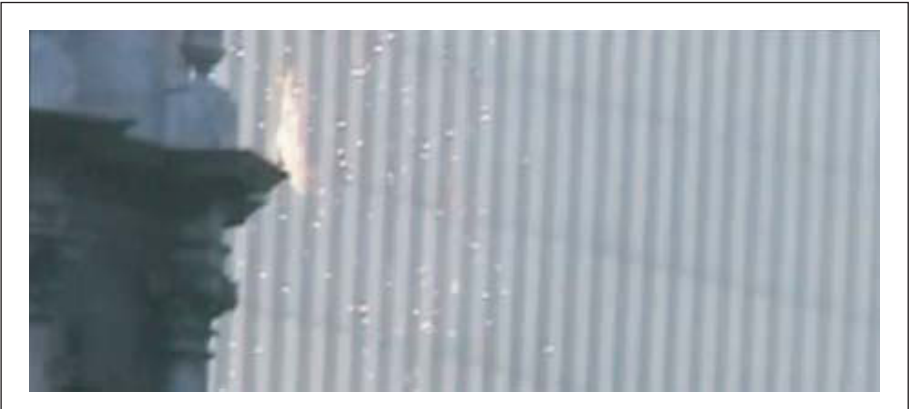

Source @00:06: <http://www.youtube.com/watch?v=LivXaOguXRA>

Molten steel was pouring out of the breaking points of the South Tower.



Source @00:52: <http://www.youtube.com/watch?v=LivXaOguXRA>



### 13.4 Ready for ignition at 50 m below entrance level

Chosen geometry for this case study (depth of burial in rock 25 m):

- 1 kt yield as primary shockwave pattern
- 26 kt yield additional slow fusion x-ray emission directed energy

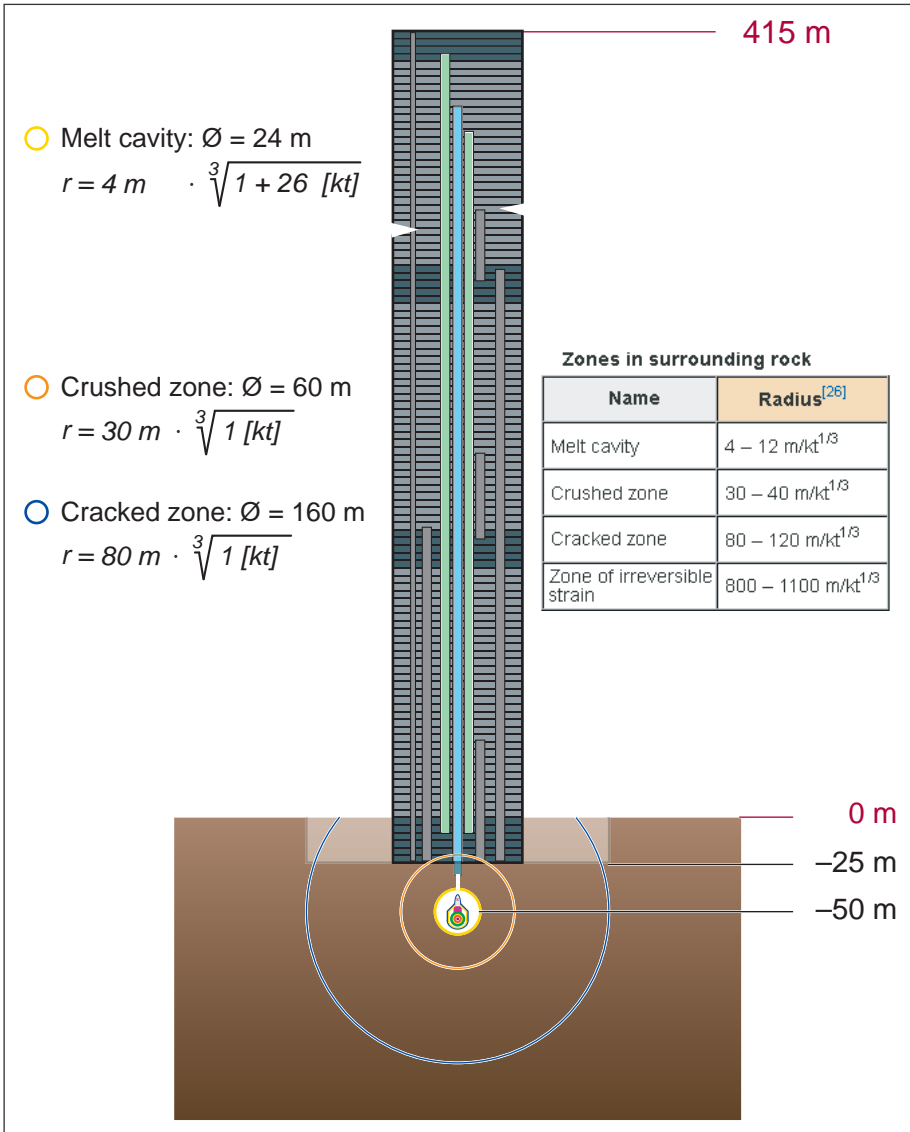

Source [data]: [https://en.wikipedia.org/wiki/Underground\\_nuclear\\_weapons\\_testing](https://en.wikipedia.org/wiki/Underground_nuclear_weapons_testing)

## 13.5 Ignition: x-ray / neutron flash in the earth

### Primary fission charge

The primary uranium-235 fission charge detonates by:

- suddenly surpassing the threshold of critical neutron flux

The result is extreme heat, pressure, x-ray and other radiation

### Reflection

Although the energy flux in a third generation nuclear weapon cannot be fully controlled, it is possible to choose a preferred direction of the x-ray / neutron flash by using reflectors.

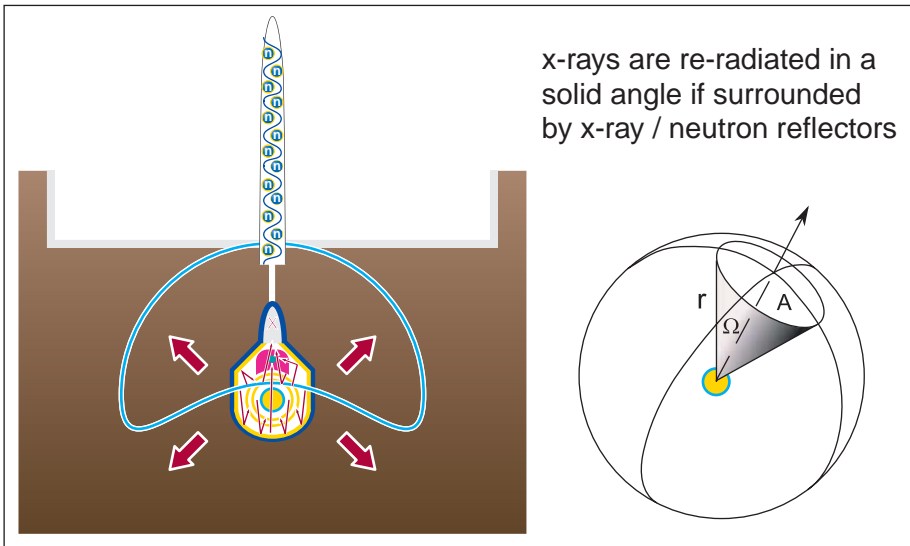

Source: [https://en.wikipedia.org/wiki/Solid\\_angle](https://en.wikipedia.org/wiki/Solid_angle)

### Secondary fusion charge

The duration of a nuclear fusion is:

- in an atmospheric H-bomb: one millionth of a second
- in the planned ITER fusion reactor: sixty seconds
- in the sun: 4.5 billion years

To achieve a long burn of the [one or several] fusion fuel capsules, a very symmetrical configuration must be ensured, to avoid hydrodynamic instabilities during compression.

# 13.6 Long fusion burn [= nuclear fizzle] and x-ray emission

A nuclear fusion can continue indefinitely, provided that there is:

- sufficient high temperature (about 1,000,000 °K)
- sufficient high pressure (about 1,000,000 bar)
- sufficient concentration of nuclear fuel

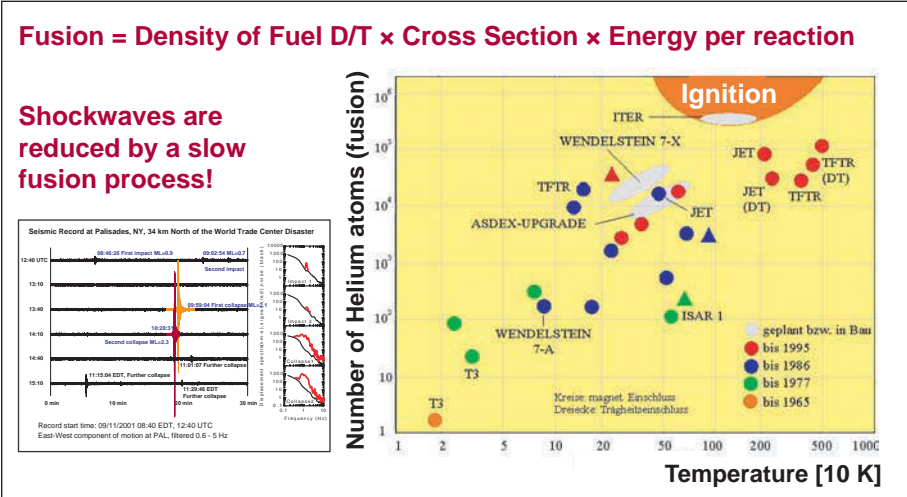

It is an **open question** how this containment was achieved in the hard rock for about 5 seconds on 9/11, resulting in extremely powerful x-ray emission upwards – and evaporating the towers' steel core.

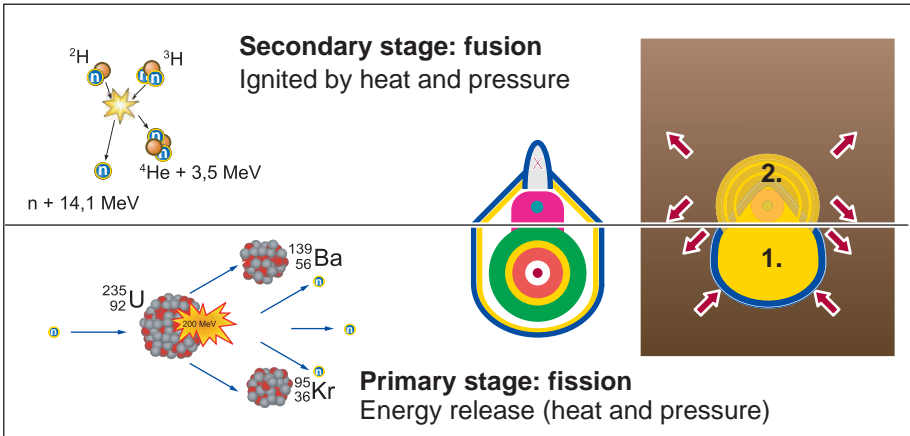

Source: [https://en.wikipedia.org/wiki/Fizzle\\_\(nuclear\\_test\)](https://en.wikipedia.org/wiki/Fizzle_(nuclear_test))

### 13.7 X-ray / neutron flash in the Tower

Situation after 0.01 seconds:

- first x-ray / neutron flash inside the Tower
- fusion still in progress
- elevator shaft plugged by liquid rock (no escaping sound wave)

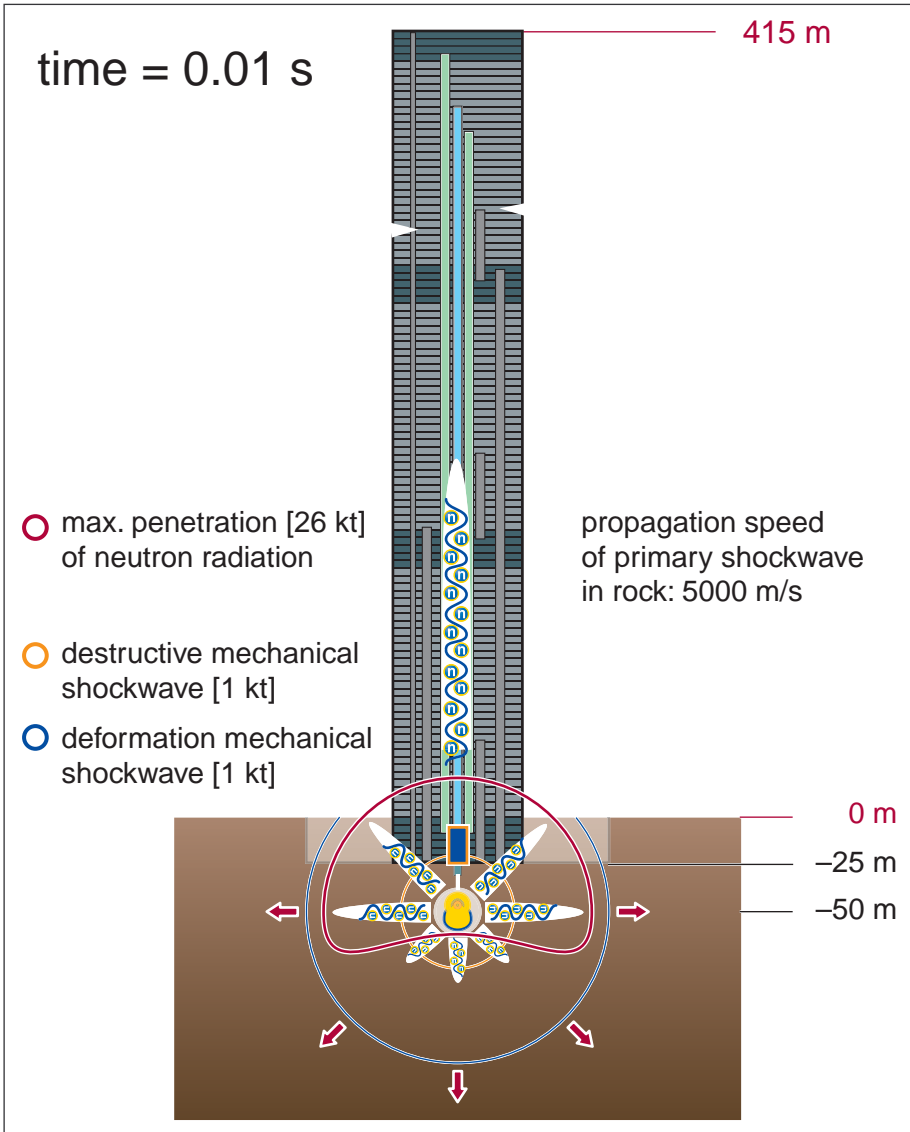

Source [data]: [https://en.wikipedia.org/wiki/Underground\\_nuclear\\_weapons\\_testing](https://en.wikipedia.org/wiki/Underground_nuclear_weapons_testing)

### 13.8 Neutron collimator

Neutron collimators were tested during nuclear weapon tests:

- a collimator acts like an aperture plate, filtering transverse rays
- the result is a directed energy beam in the desired direction
- a tunnel inside the rock forms an excellent collimator [on 9/11]

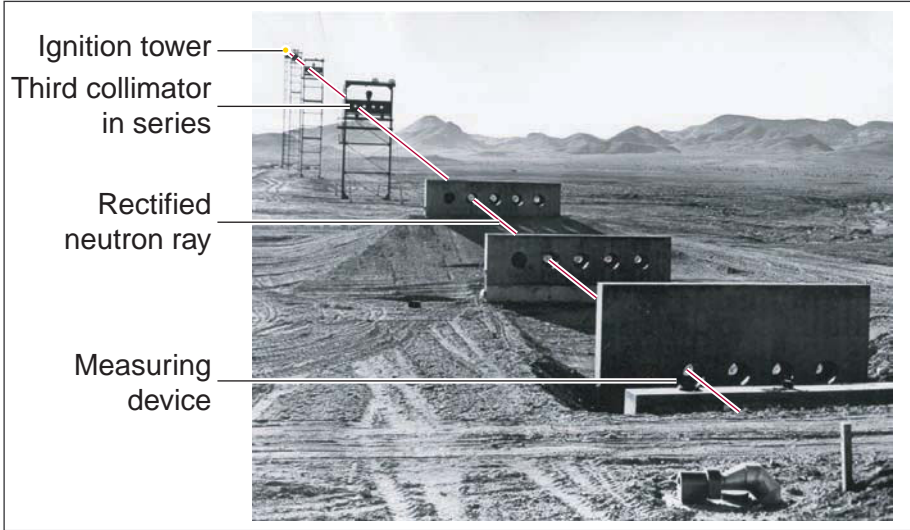

Source: <https://en.wikipedia.org/wiki/Collimator#/media/File:NNSA-NSO-190.jpg>

Neutron collimators exist also on laboratory scale.

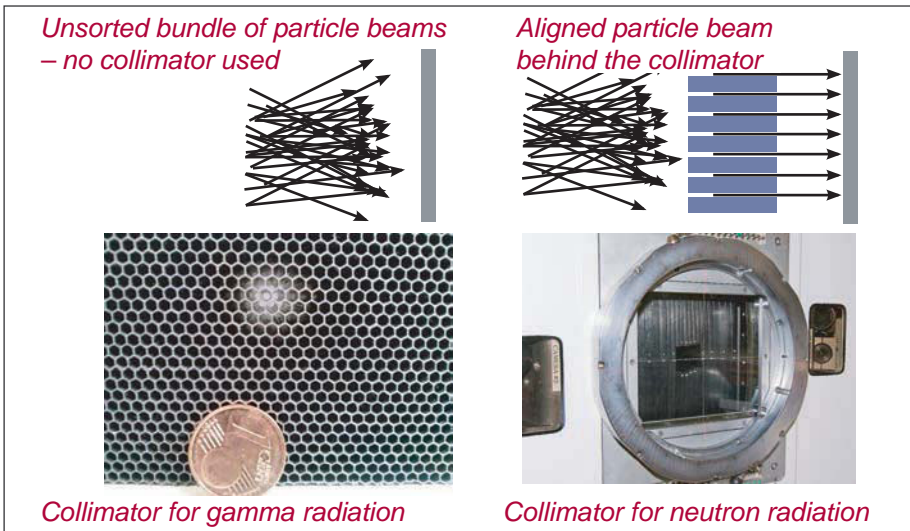

Source: <https://en.wikipedia.org/wiki/Collimator>

### 13.9 X-ray softening the Tower's steel core / vertical EMP

Situation after 1 second:

- x-ray radiation from below, being absorbed by the steel core
- fusion still in progress
- elevator shaft plugged by liquid rock, cavities growing

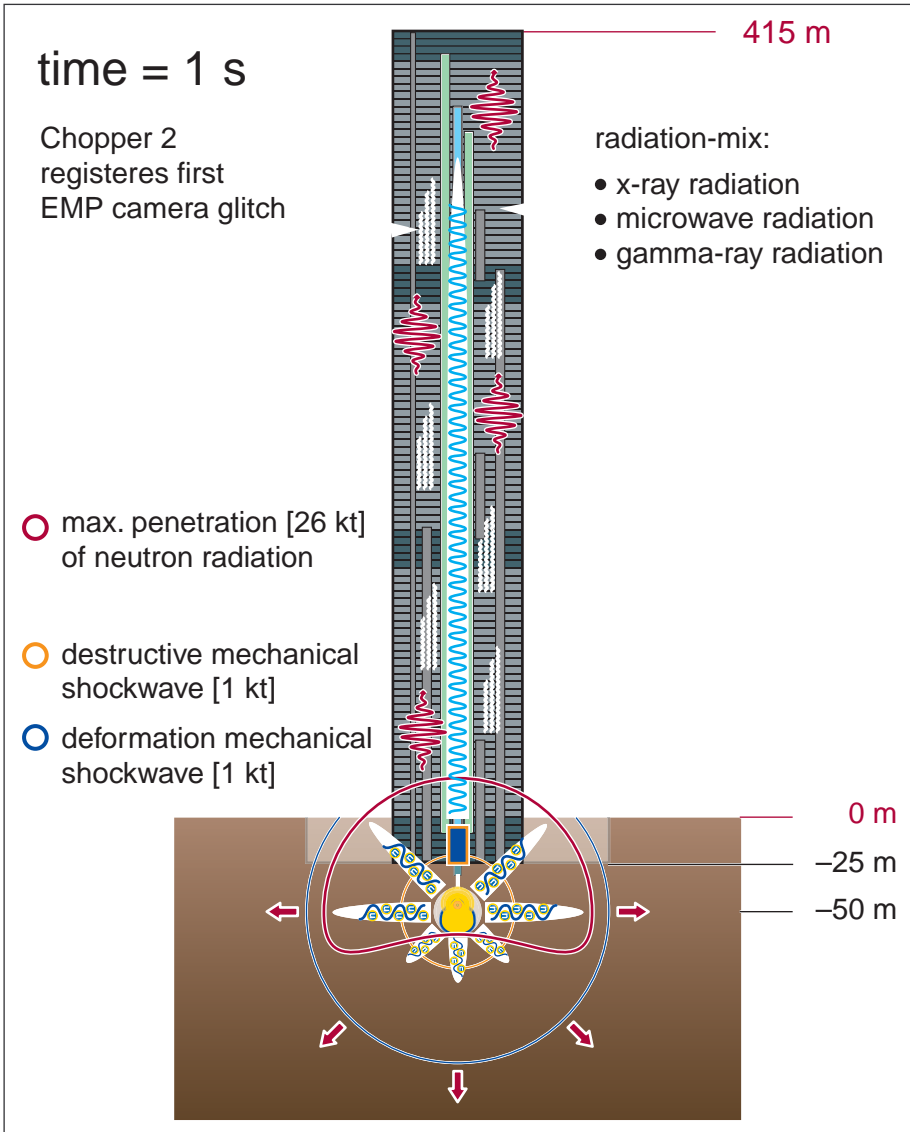

Source [data]: [https://en.wikipedia.org/wiki/Underground\\_nuclear\\_weapons\\_testing](https://en.wikipedia.org/wiki/Underground_nuclear_weapons_testing)



### 13.10 Overpressure in liquid rock chambers

Situation after 6 second:

- x-ray radiation declining, steel core softened
- fusion terminated, high radioactivity levels in the melt cavity
- liquid rock chambers at maximum pressure

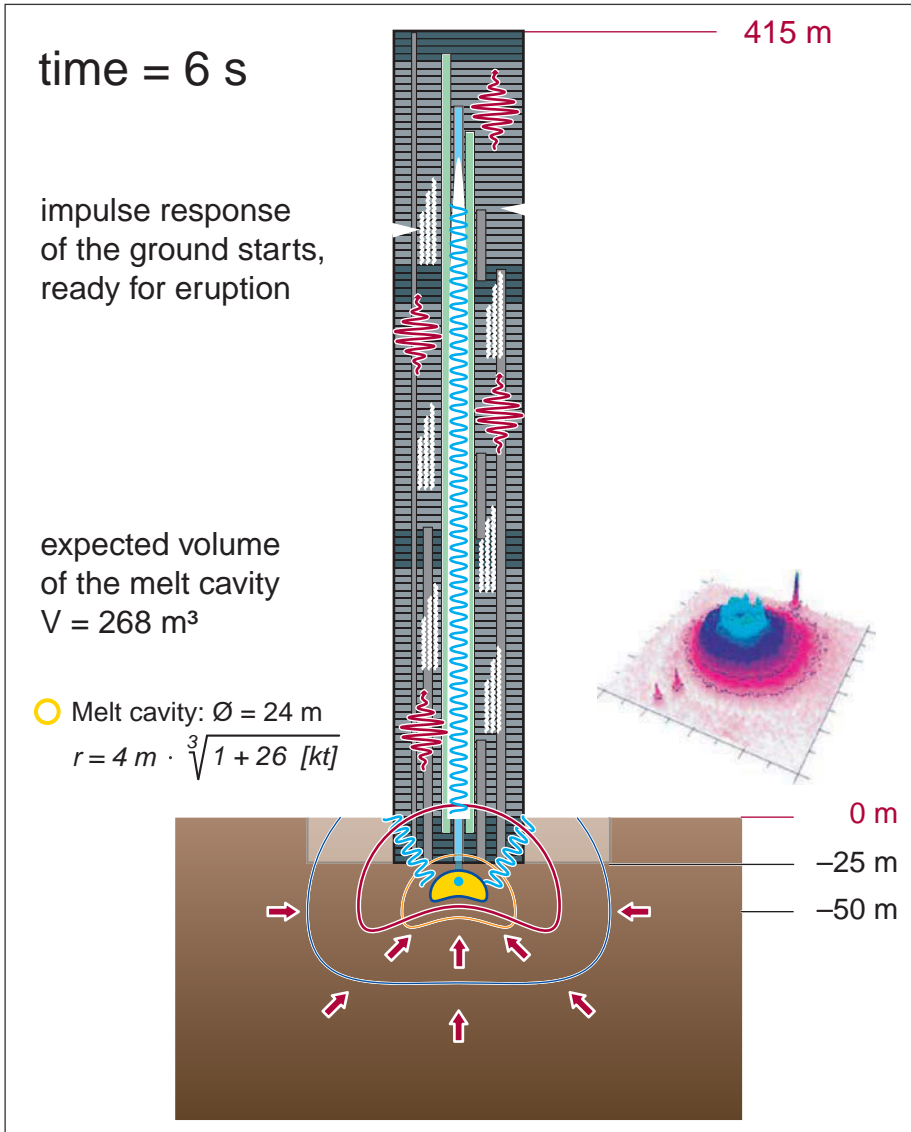

Source [Impulse response]: <http://arxiv.org/abs/1309.3083v1>

### 13.11 Bursting chambers and nuclear plasma upshot

Situation after 8 second:

- liquid rock chambers bursts open inside the elevator shafts
- nuclear plasma upshot with 8,000 °C inside the steel core
- pressure, heat and radioactivity are released in the tower

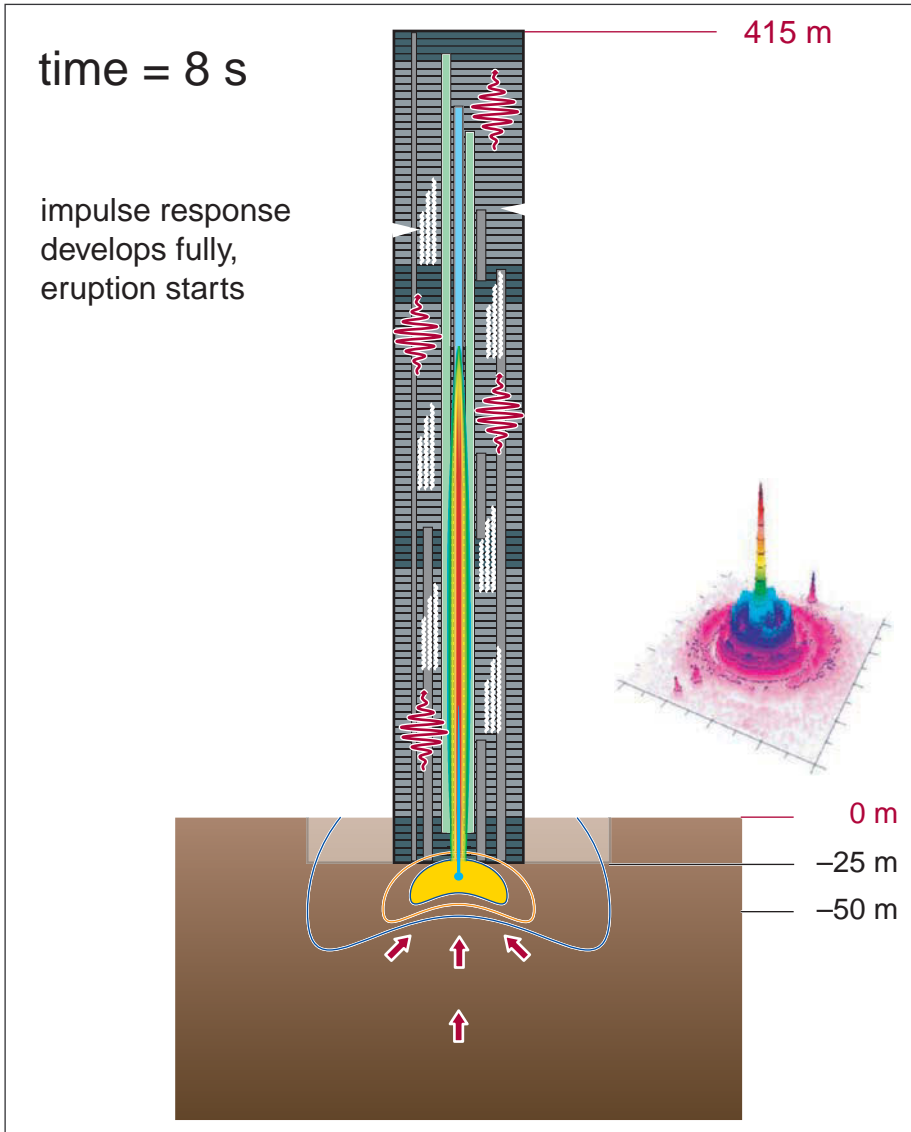

Source [Impulse response]: <http://arxiv.org/abs/1309.3083v1>

### 13.12 First visible eruption on top / Faraday cage opens

Situation after 9 second:

- liquid rock chambers further compressed
- nuclear plasma upshot reaches the building's top
- visible eruption starts with pressure equalization at impact zone

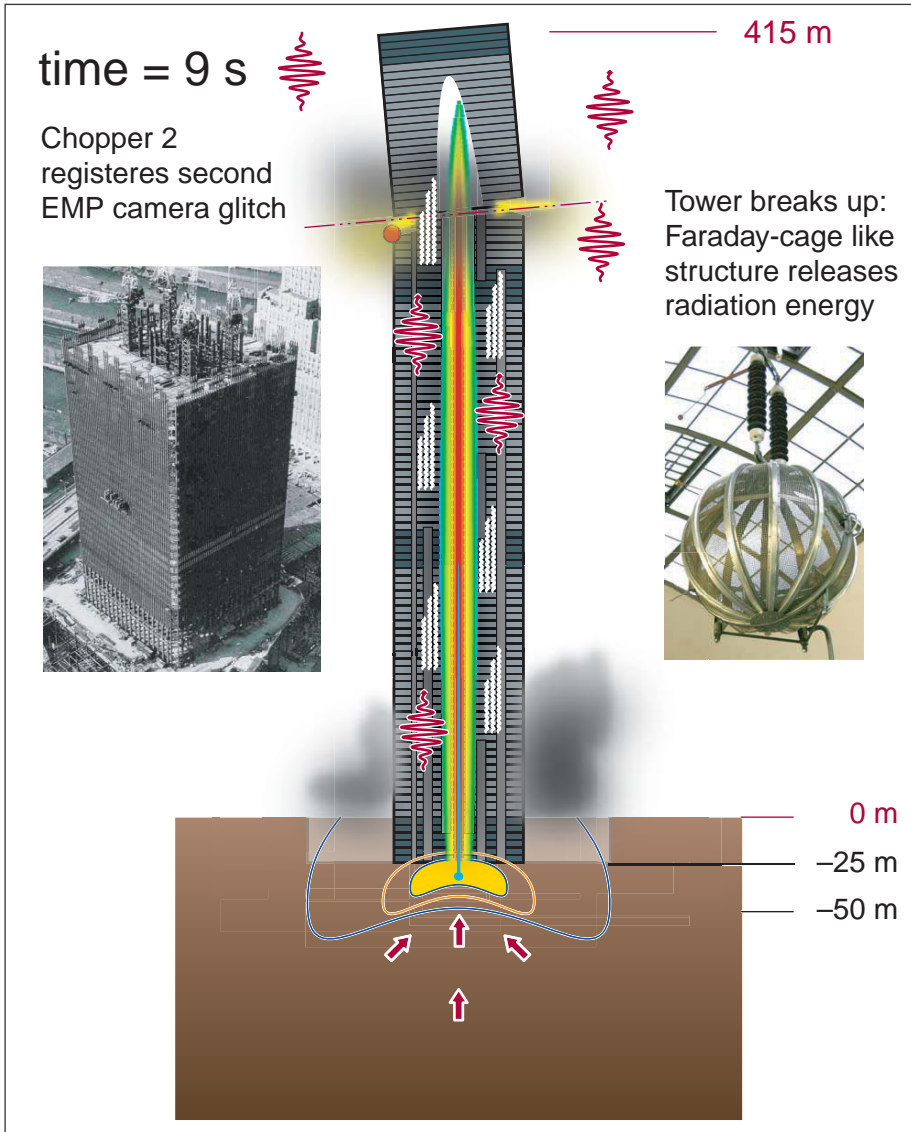

Source: [https://en.wikipedia.org/wiki/Faraday\\_cage](https://en.wikipedia.org/wiki/Faraday_cage)

### 13.13 Full eruption / release of secondary EMP

Situation after 15 second:

- liquid rock chambers to be completely emptied
- material shooting out by inertia, like erupting from a nozzle
- ground deformation stopped, depressurizing

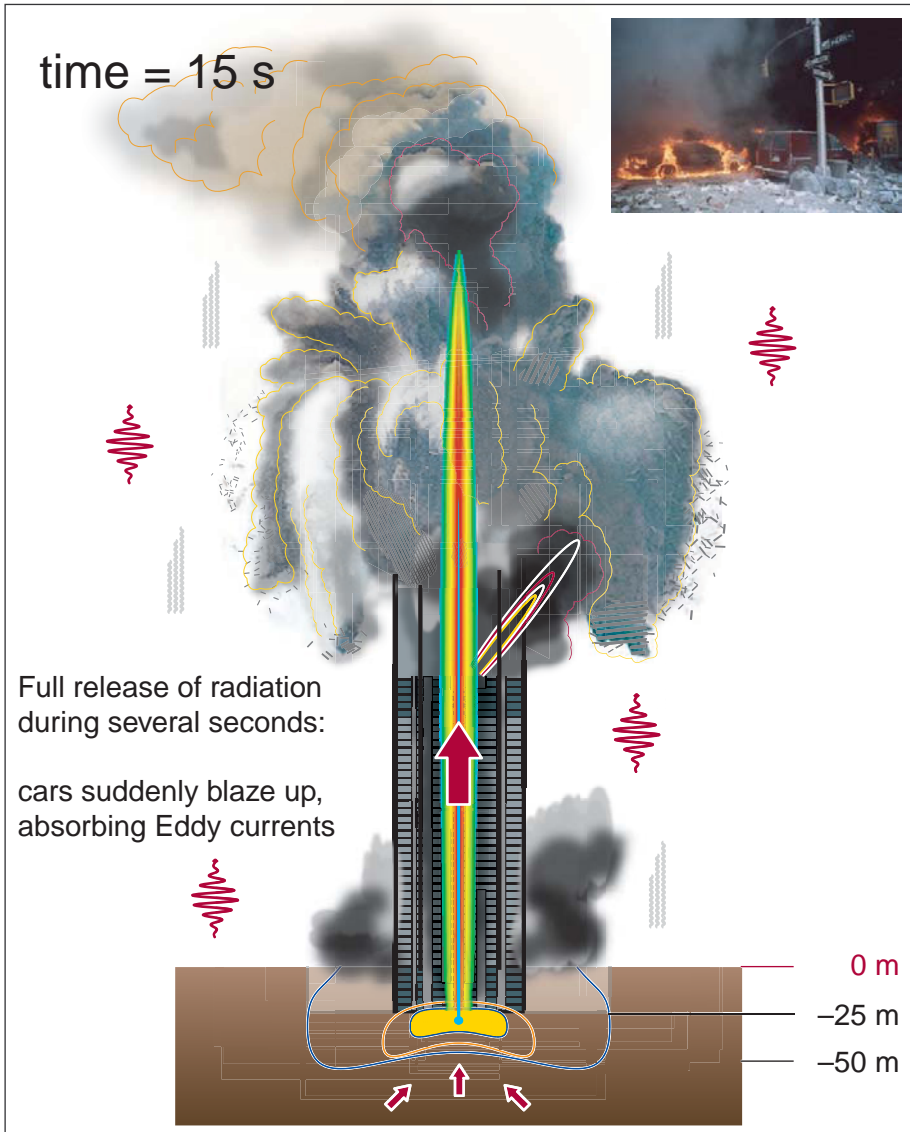

Source: [https://en.wikipedia.org/wiki/Eddy\\_current](https://en.wikipedia.org/wiki/Eddy_current)

### 13.14 Radiation shield: Memorial Pools / Tribute in Light

Situation after 16 years:

- 'Memorial Pools' as radiation shields installed
- 'Tribute in Light' mocking the blue Cherenkov radiation caused by radioactivity

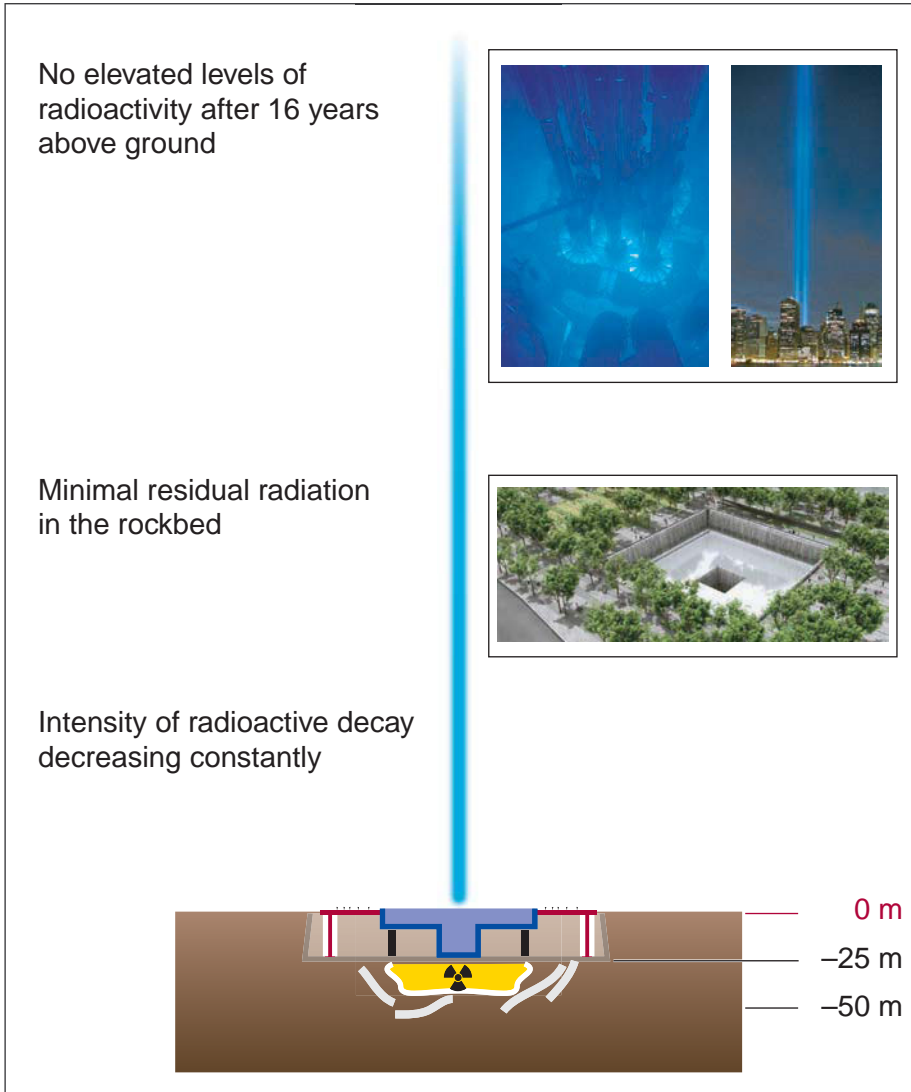

Source 1: [https://en.wikipedia.org/wiki/National\\_September\\_11\\_Memorial\\_&\\_Museum](https://en.wikipedia.org/wiki/National_September_11_Memorial_&_Museum)

Source 2: [http://en.wikipedia.org/wiki/Cherenkov\\_radiation](http://en.wikipedia.org/wiki/Cherenkov_radiation)

# 14 Delayed Electro-Magnetic Pulse EMP

## The expected EMP was 12 seconds late

Normally an EMP pulse is released at the same time when the nuclear device is detonated.

However, due to the Towers' outer steel structure, they represented a Faraday cage: electromagnetic radiation was trapped inside.



Faraday cage:  
to capture / shield  
energy pulses

Source 1: <http://www.boweryboyshistory.com/wp-content/uploads/2008/09/site1099.jpg>

Source 2 (Deutsches Museum): <http://www.fotocommunity.de/pc/pc/display/35889571>

Cars went up in flames simultaneously with the Towers' eruption because the trapped radiation was suddenly released.



Source: <http://www.abidemiracles.com/images/terrorism/911nukes/>



## The metal fence 'reflecting radiation barrier'

Just like the metal grid at a microwave oven window, the metal fence made of wire mesh acts as a 'reflecting radiation barrier':

- cars just in front of the 'reflecting radiation barrier' are ignited
- cars some meters further away or behind the fence are shiny

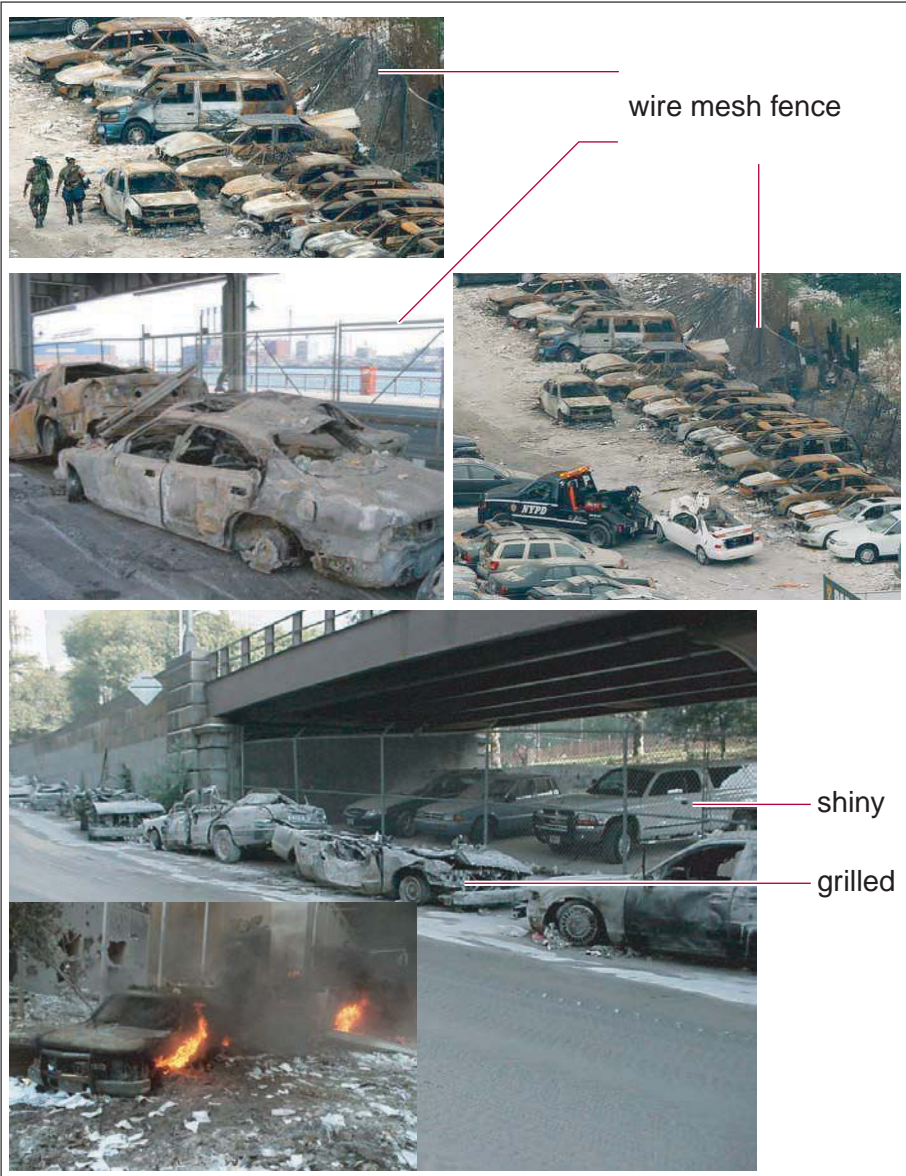

Source: <http://www.abidemiracles.com/images/terrorism/911nukes/>

# 15 Neutron absorption and isotopes

**Neutron absorption = higher atomic weight = new isotope**

- if the new isotope is radioactive, we speak of 'neutron activation'
- if the new isotope is stable we speak of 'non-activation'

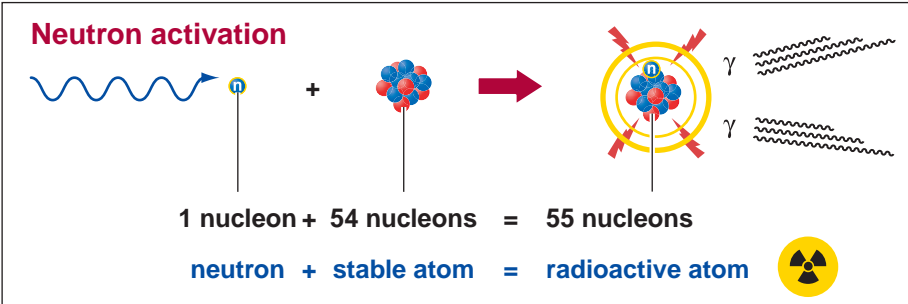

Source: <https://en.wikipedia.org/wiki/Nucleon>

## Elements which are susceptible to neutron activation

Many elements are stable in just one isotope configuration. This is the case for iodine-127 and beryllium-9, for example.

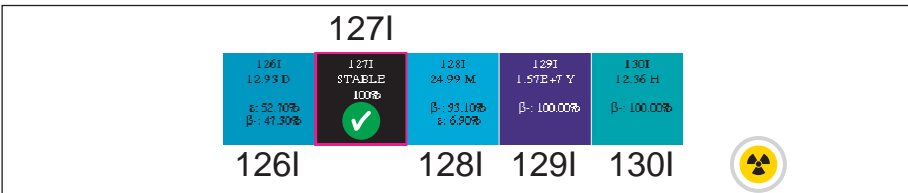

Source: <http://www.nndc.bnl.gov/chart/reCenter.jsp?z=53&n=74>

## Elements which resist neutron activation

Iron-56 for example will easily absorb two neutrons, remaining stable. In this case a Geiger counter is useless for proving a nuclear process.

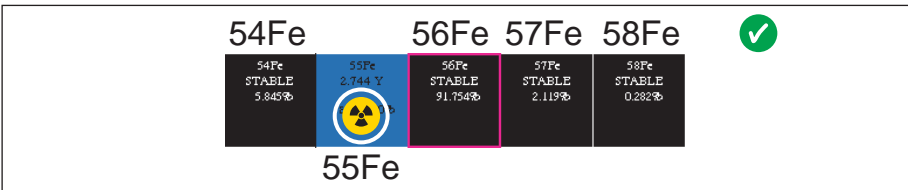

Source: <http://www.nndc.bnl.gov/chart/reCenter.jsp?z=26&n=30>

# 16 Neutron reflection and scattering

## Neutron reflection

- not all atoms "like" neutrons: they reject them

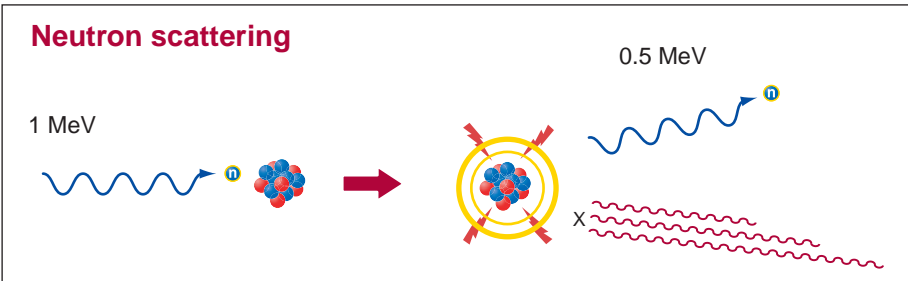

Source: <https://en.wikipedia.org/wiki/Nucleon>

The table reveals that iron has outstanding characteristics to scatter neutrons. This means: it will heat up extremely, but not turn radioactive.

Cross Sections [Wirkungsquerschnitte]		Thermal cross section (barn)			Fast cross section (barn)		
		Scattering	Capture	Fission	Scattering	Capture	Fission
Moderator [Neutronen-Moderator]	H-1	20	0.2	-	4	0.00004	-
	H-2	4	0.0003	-	3	0.000007	-
	C (nat)	5	0.002	-	2	0.00001	-
Structural materials, others [Elemente mit Strukturgitter / andere Elemente]	Au-197	8.2	98.7	-	4	0.08	-
	Zr-90	5	0.006	-	5	0.006	-
	Fe-56	10	2	-	20	0.003	-
	Cr-52	3	0.5	-	3	0.002	-
	Co-59	6	37.2	-	4	0.006	-
	Ni-58	20	3	-			
Absorber [Neutronen-Absorber]	O-16	4	0.0001	-			
	B-10	2	200	-			
	Cd-113	100	30,000	-			
	Xe-135	400,000	2,000,000	-			
Fuel [Kern-Brennstoff]	In-115	2	100	-			
	U-235	10	99	583 <sup>[5]</sup>			
	U-238	9	2	0.00002			
	Pu-239	8	269	748			

Source: [https://en.wikipedia.org/wiki/Neutron\\_cross\\_section](https://en.wikipedia.org/wiki/Neutron_cross_section)

# 17 Radiation shockwaves: from iron to dust

## Shockwave reflection

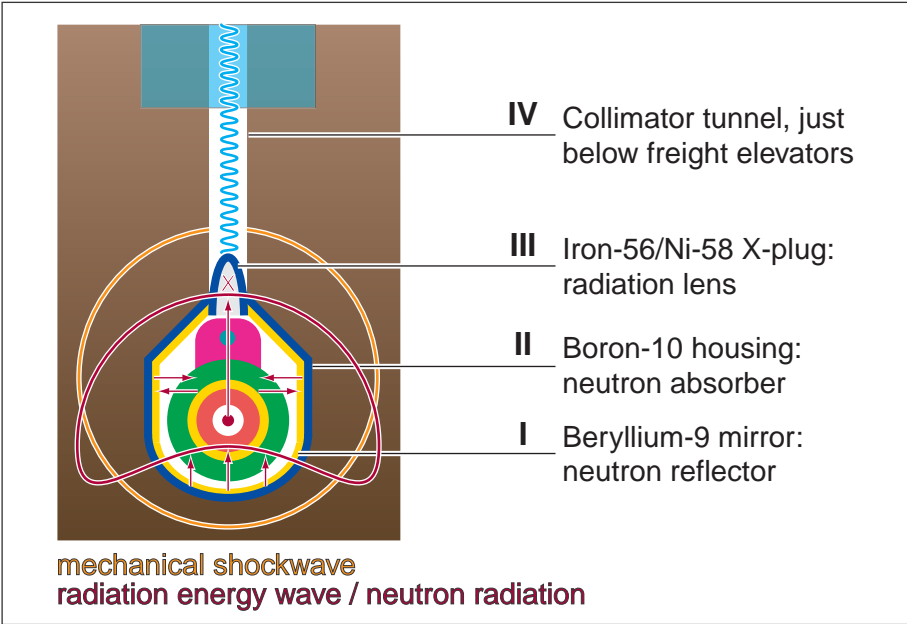

Source [modified]: <https://arxiv.org/pdf/physics/0510071>

### NOTE

The mechanical shockwave passes the system without being bent.

### Mechanism

1. circular neutron radiation shockwave hits Beryllium-9 reflector (I)
2. some of the neutron radiation is reflected upwards 
3. circular shockwave thus changes to kidney-shaped shockwave
4. neutrons enter X-plug (III), being scattered and/or absorbed
5. the neutrons' energy is partly re-radiated as powerful x-ray
6. remaining neutron radiation and x-ray pass the collimator tunnel (IV)
7. the powerful and focused energy beam enters the buildings's core
8. neutron radiation which does not leave the X-plug is absorbed by the Boron-10 housing, thus preventing neutron activation of the environment (II)

Boron-10 changes after neutron absorption to stable isotope boron-11.

## From iron to dust

If the short energetic radiation pulse has the right wavelength, the chemical bonds in the iron crystal will be broken:

- the radiation energy is absorbed

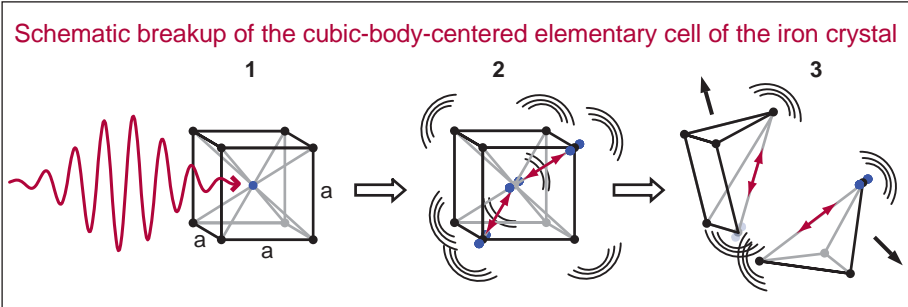

Source [modified]: [edoc.ub.uni-muenchen.de/1215/1/Windhorn\\_Lars.pdf](http://edoc.ub.uni-muenchen.de/1215/1/Windhorn_Lars.pdf)

## Black dust wave of steel powder

Airborne iron powder blacks out sunlight, it appears as pitch black.

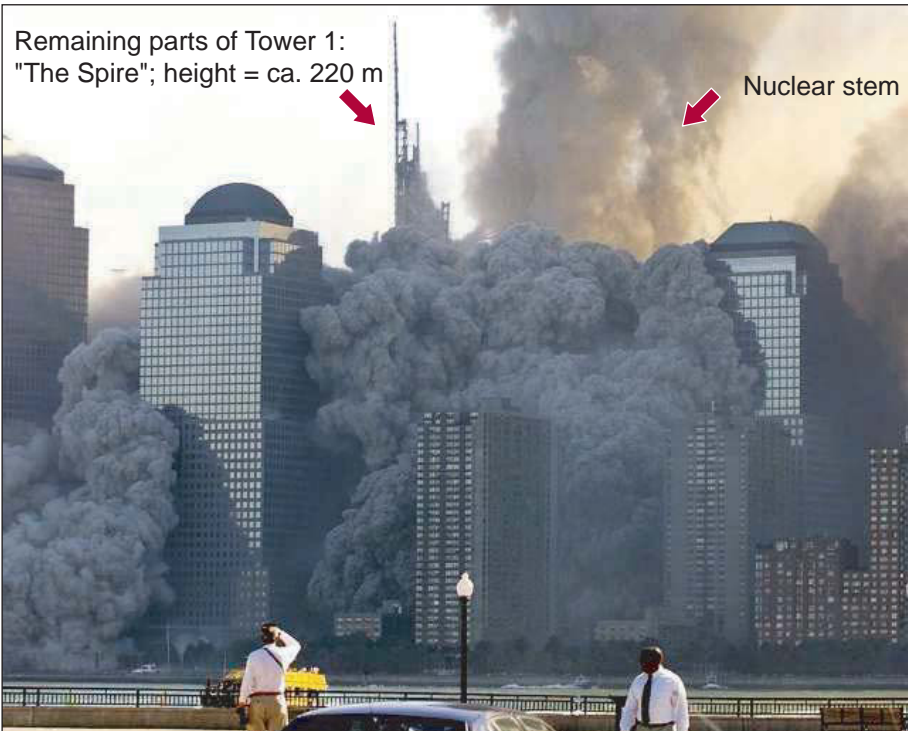

Source: <http://911research.wtc7.net/wtc/evidence/photos/wtc1spire.html>

# 18 Steam explosions: from concrete to dust

## From concrete to dust

The water inside the concrete crystal absorbs the radiation energy like in a microwave oven:

- it suddenly turns to overheated steam and rips the crystal apart

Radiation hits water in a crystal

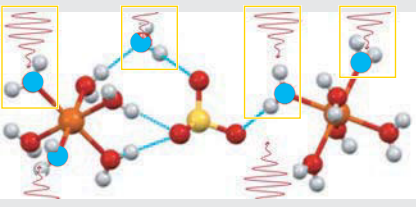

The water itself acts as a micro-explosive when being hit

Solid concrete walls turn as brittle as a sandcastle dried up in the sun

-> destruction by steam explosion

The diagram illustrates a crystal lattice structure with water molecules (red and white spheres) embedded within it. Red wavy lines representing radiation are shown hitting the water molecules. Yellow boxes highlight the interaction points. The text explains that this process turns the water into a micro-explosive, making the concrete brittle.

Source: [https://en.wikipedia.org/wiki/Steam\\_explosion](https://en.wikipedia.org/wiki/Steam_explosion)

Huge blocks of concrete were thrown out of the building, rotating and getting smaller, dissolving into dust.



Source (video) @ 00:27: <https://www.youtube.com/watch?v=dueVm1UGvXo>



# 19 Intact paper

## Energy absorption

Iron / concrete have a high absorbance:

- the absorbed energy destroys the molecular bonds

Light materials such as paper have a low absorbance:

- the energy does not suffice to break the molecular bond

## Situation for iron

Absorption of energy and dissociation at  $D_e$  of the cubic-body-centered elementary cell of the iron crystal

[at corresponding wavelength  $\lambda$ ]

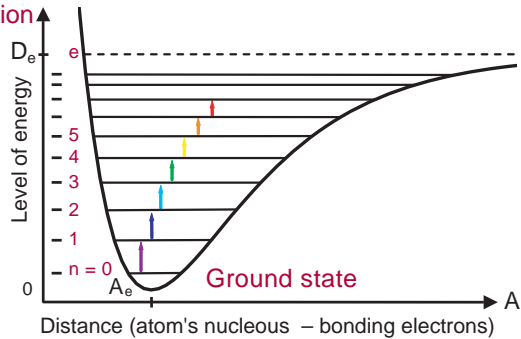
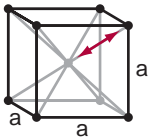

Source: <http://de.wikipedia.org/wiki/Eisen#/media/File:Cubic-body-centered.png>

## Situation for paper

As paper has no crystal structure, it cannot absorb the radiation.

- paper stays intact: like a blade of grass bends in the storm



metallic objects:  
in flame by radiation

paper / light objects:  
unharmd by radiation

Source: <http://www.abidemiracles.com/images/terrorism/911nukes/>

## 20 Killing our own

This was the title of a book describing 'The Disaster of America's Experience with Atomic Radiation', published in 1982.

It details the crimes of exposing approximately 300,000 soldiers and civilians to radiation effects between 1945 and 1960.

In the preface of that book there is a quote of Albert Einstein, made in 1947:

We scientists recognize our inescapable responsibility to carry to our fellow citizens an understanding of the simple facts of atomic energy and its implications for society.

In this lies our only security and our only hope – we believe that an informed citizenry will act for life and not death.

Today, the citizens are not informed.

We are disinformed.

And the scientists do not meet their responsibility – by design or by inaction – to warn of the abuse, in which we have engaged collectively.

The physical effects of 9/11 can be explained easily, easily and completely.

The radioactive isotopes in the dust samples and below the Memorial Pools hold the answer.

The stable iron isotopes 57 and 58 hold the answer.

The suspected uranium isotope 235 – needed for the fission bomb – holds the answer.

More than fifteen years have passed, and when it comes to 9/11 all institutions have failed us, and continue to fail us.

The question is: why?

When were we given away? What, if the crime never stopped?

What, if the crime started long ago and is rooted in our history?

# 21 Radioactive dust samples

The United States Geological Survey USGS collected dust samples from over 30 places in Manhattan:

- decay elements from the uranium fission process were found

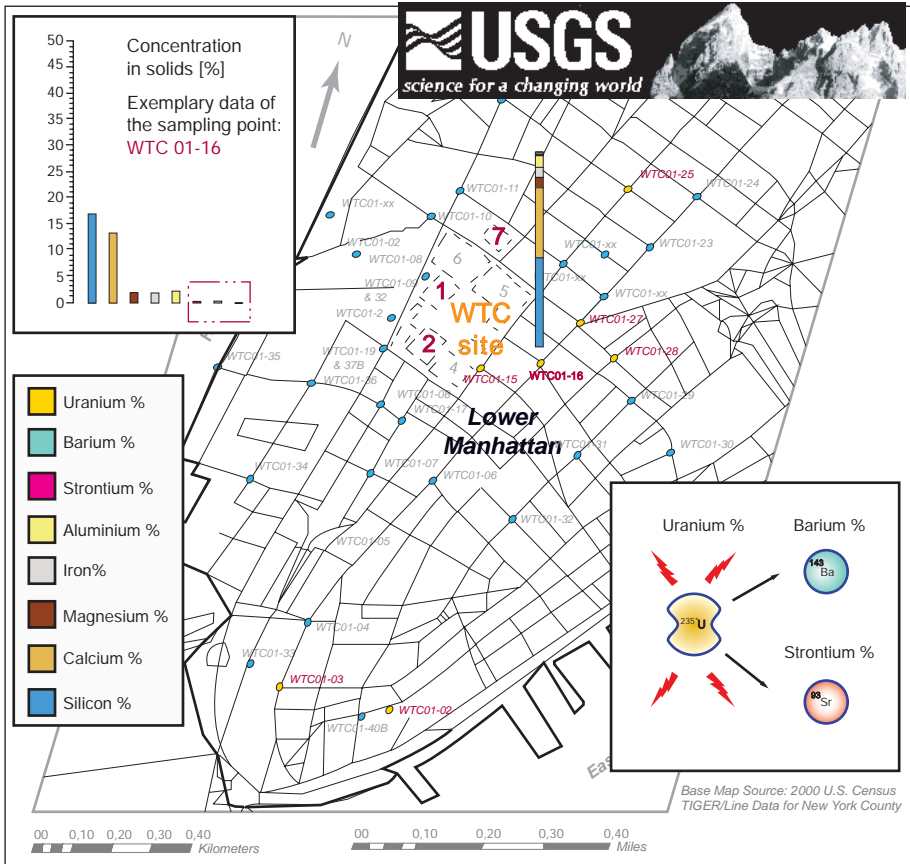

Source (edited): <http://pubs.usgs.gov/of/2001/ofr-01-0429/chem1/index.html#Sampling>

Also present in the dust were the [always radioactive] starting materials:

- uranium
- thorium (which is the alpha-decay product from uranium)

Chemistry Table 1, continued					
ppm - parts per million	minimum	maximum	mean*		
Thorium ppm	5.36	30.7	9.31		
Uranium ppm	1.96	7.57	3.29		

Source: <https://pubs.usgs.gov/of/2001/ofr-01-0429/chem1/WTCchemistrytable.html>

## 22 Residual radiation in the Bathtub

### Dirt as de-contamination effort

Earth was quickly spread over the debris, even far away from walking lines. Senseless for a cleanup, but useful for containing radiation.



Source (photos brightened): <http://drjudywood.com/articles/dirt/dirt3.html>



## Rust – sudden and extreme

Radioactivity damages the iron crystal structure and allows oxygen to enter deep into metallic objects:

- on site, metallic objects got extremely rusty on 9/11
- even after months new constructions suffered from oxidation

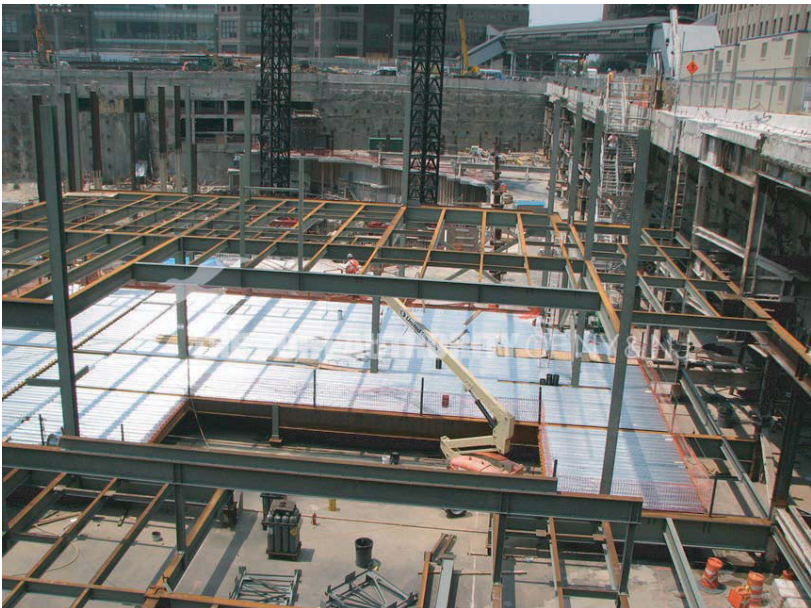

Source: <http://drjudywood.com/articles/dirt/dirt4.html>

# 23 Radiation cancers

## Thyroid cancers: a proof of radioactive iodine

Especially when radioactivity and toxic fumes are both involved it is not possible to track down the cause of cancer individually.

- however, one chemical element stands out as a rule: iodine

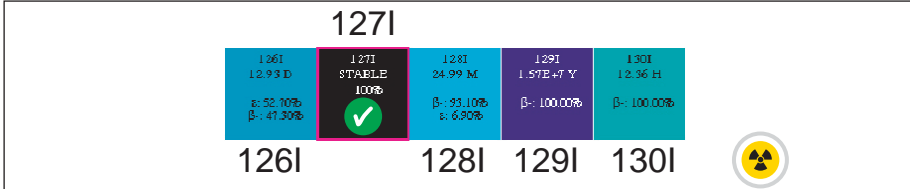

Source: <http://www.nndc.bnl.gov/chart/reCenter.jsp?z=53&n=74>

Only iodine-127 is safe, as only iodine-127 is stable:

- but ALL iodine isotopes will be absorbed by your thyroid

There is a clear correlation between the 9/11 thyroid cancer cases and the number of 9/11 rescue workers on site.

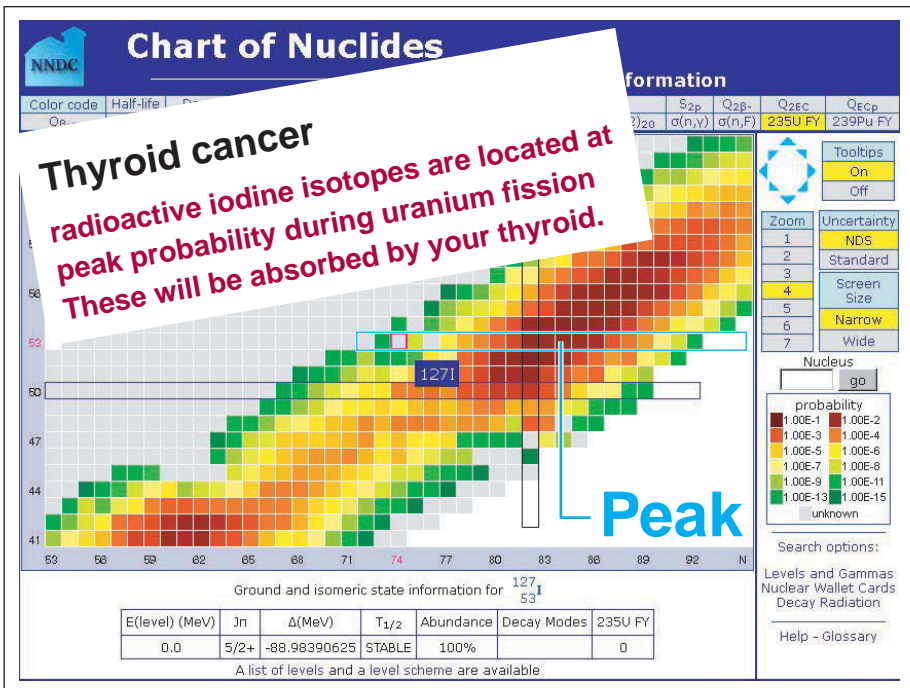

Source: <http://www.nndc.bnl.gov/chart/reCenter.jsp?z=26&n=30>



## Cancer waves

Due to 9/11 about:

- 3,000 people died instantly in the towers
- 2,000 people already died of cancer [2017]
- 5,400 people are currently sick with cancer [2017]
- 72,000 people need medical care

# MailOnline

Home **News** | U.S. | Sport | TV&Showbiz | Australia | Femail | Health | Science | Money |

Latest Headlines | News | World News | Arts | Headlines | France | Pictures | Most read | Wires | Discounts

## Donna Summer said toxic dust from 9/11 gave her fatal lung cancer. Crazy? 60,000 others say they're blighted, too

Source: <http://www.dailymail.co.uk/news/article-2146629>

Furthermore, millions of people were killed in the wars that followed, and so 9/11 continues to kill, also in form of cancer waves yet to come.

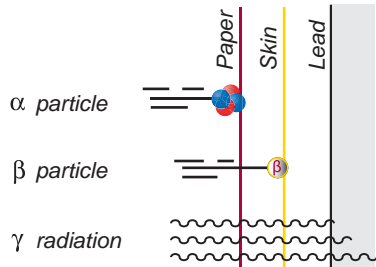
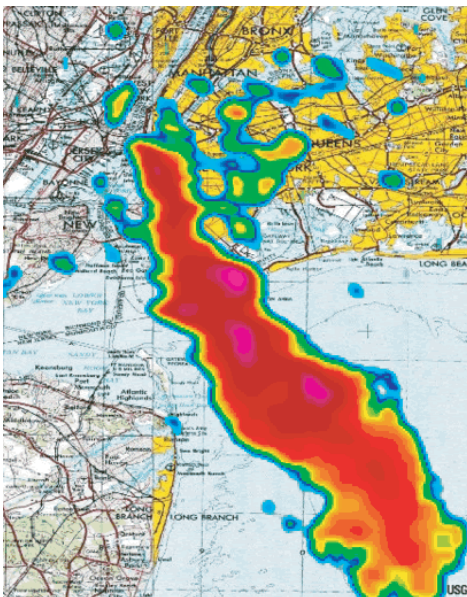

Very aggressive, if inhaled:  
alpha particle

Causing cancer deep inside:  
beta particle / gamma rays

Acting only as a mechanical  
carcinogen: asbestos  
10 – 20 years to develop

[http://en.wikipedia.org/w/index.php?title=File:New\\_York\\_September\\_11\\_NEXRAD.png](http://en.wikipedia.org/w/index.php?title=File:New_York_September_11_NEXRAD.png)

## 24 The devil's trap for the Mossad

On September 11, 2001, at about 10 a.m., former Israeli prime Minister Ehud Barak was coincidentally in the BBC in London:

- his words started the "war on terror" as we know it today



Source: <https://www.youtube.com/watch?v=GAueLjdKh1s>

“If it is a kind of Bin Laden organization [which is behind it]...”

“I believe [that] this is the time to deploy a globally concerted effort led by the United States [...] against all sources of terror.”

### Control over US institutions

On every level and in decisive positions we can identify agents who were working against the interests of the United States, controlling or influencing:

- the White House
- the Pentagon
- the military information systems
- the justice system
- the WTC complex
- the National Institute of Standards and Technology (NIST)
- the media
- the finances

## "We are not your problem" (Mossad agents on 9/11)

On 9/11 five men were spotted shortly after 8:46 a.m., taking pictures of the towers and celebrating the first plane's impact.

- In the afternoon the group was arrested at gunpoint by Officer Scott DeCarlo and Sergeant Dennis Rivelli

The five turned out to be Israeli and were released by Michael Chertoff.



"We are Israeli. We are not your problem. Your problems are our problems. **The Palestinians are the problem.**"

**Sivan Kurzberg**



"I was serving in a special unit in [...]. And it's not a big secret or something like that. But I think that I have to keep [that] to myself, as [I am] loyal to my country."

**Paul Kurzberg**



"When you hear their story, [is that] they want to believe [it], its insane; o.k – maybe I'm a spy."

**Yaron Schmucl**



"And at that point we were taken for another round of questioning. This time related to us allegedly being members of Mossad."

**Oded Ellner**

"The fact of the matter is, we are coming from a country that experiences terror daily. Our purpose was to document the event."



"US law officials, policemen and jailers arrested [us] illegally, for a long and protracted period, and violated [our] human rights..."

**Omer Marmari**

Source 1: <http://www.voltairenet.org/article179295.html>

Source 2: <https://www.corbettreport.com/911-suspects-dancing-israelis/>

Source 3: <http://www.haaretz.com/israelis-arrested-on-9-11-sue-u-s-1.134899>

## Controlling the White House



“It is very good. Well not good but it will immediately get people to sympathize [with Israel]”

**Benjamin Netanyahu**



“From today on, the world will never be the same again, this is an attack against our whole civilization.”

**Ehud Barak**



- Ari Fleischer to George W. Bush on 9/11 during the school visit

“DON'T SAY ANYTHING YET”

**Ari Fleischer**

Source 1: <http://jewishcrimenetworkdid911.blogspot.de/>

Source 2: [https://wikispooks.com/wiki/9-11/Israel\\_did\\_it](https://wikispooks.com/wiki/9-11/Israel_did_it)

## Controlling the Pentagon

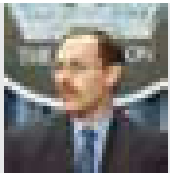

- Dov Zakheim is responsible for the disappearance of 2.6 trillion US \$ from the defense budget



- Richard Perle, also known as “prince of darkness”, was responsible for the strategic orientation of the Pentagon

### Paul Wolfowitz: America's Strategy, Forces and Resources For a New Century



“Further, the process of transformation, even if it brings revolutionary change, is likely to be a long one, absent some catastrophic and catalyzing event – like a new Pearl Harbor”

Source 1: <http://www.informationclearinghouse.info/pdf/RebuildingAmericasDefenses.pdf>

Source 2 @ 01:57:00 (B. Honegger): <https://www.youtube.com/watch?v=VXBk8JqwFlw>

## Control of the information systems / of the evidence



- The national-security air defence system **was running on Ptech software.** The links to the israeli run database company Guardium allowed easy access to the system, creating "planes" on the screen



- SPS System Planning Corporation was specialized in methods for remote airplane control and "Destruction at Flight Termination" From 1987 – 2001, **Dov Zakheim** was managing director at SPS



- Alan D. Ratner's 'Metals Management SIMS group' shipped the WTC scrap hastily to China – **50,000 tons of steel** Before being shipped, the scrap was mixed with other iron scrap

Source 1: <https://www.corbettreport.com/ptech-and-the-911-software/>

Source 2: <https://www.youtube.com/watch?v=-Laaq44SDgg>

## Control of the justice system



- Michael Chertoff arranged the release and the return to Israel of more than a hundred Israeli agents including those that had filmed the impact of the planes into the WTC



- Michael Mukasey granted Larry Silverstein the insurance sum of 4.55 billion US \$



- Ronald Lauder forcefully implemented the privatization of the WTC complex

Source 1: <http://jewishcrimenetworkdid911.blogspot.de/>

Source 2: <http://empirestrikesblack.com/2011/09/september-11-2001-zionist-shock>

## Control over the WTC complex



- Larry Silverstein leased the WTC only a few weeks before the attacks  
He immediately took out high insurances against terror attacks involving airplanes.  
Received payout was 4,55 billion US \$



- Jules Kroll / Kroll Associates was responsible for the WTC building security  
  
He was the owner of the security firm Kroll Associates



- Lewis Eisenberg arranged the lease contract of the WTC complex with Silverstein  
He is a member of the 'Jewish Anti Defamation League' (ADL) and the 'United Jewish Appeal'



- in May 2001, Frank Lowy's company 'Westfield America', rented retail areas on the WTC basement floor for 127 million US \$ – with a contract term of 99 years

Source 1: <http://jewishcrimenetworkdid911.blogspot.de/>

Source 2: [https://wikispooks.com/wiki/9-11/Israel\\_did\\_it](https://wikispooks.com/wiki/9-11/Israel_did_it)

## Control over the National Institute of Standards and Technology



- Philip Zelikow is responsible for the final NIST report published under the name '9/11 Commission Report'

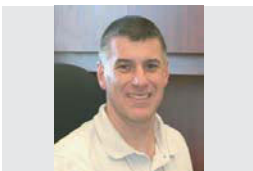

- Stephen Cauffman was the head of the chronically fraudulent and inaccurate NIST investigation as well as the cover-up related to the WTC 7 collapse

Source <http://www.lostscribemedi.com/news/911-israels-masterpiece/>



## Control over the media – BBC World on air with Jane Standley



- The collapse of WTC 7 was broadcast 20 minutes before the actual “surprising” collapse – LIVE with the building still standing in the background



“Jane, what more can you tell us about the Solomon Brothers' Building and its collapse?”

Source: <https://www.youtube.com/watch?v=M26-B44qQIs>

## The devil's trap: is Israel really needed for the New World Order?



In the NWO agenda Israel only has to fulfill a function.

It was founded with collaboration of – or by request of – the Rothschild Banking Group

Source: <http://humansarefree.com/2013/11/complete-list-of-banks-ownedcontrolled.html>

The promise of a "Greater Israel" seems to lead systematically to the destruction of the US and Israel – is this all part of the plan?

So, should we understand Henry Kissinger's words differently? Kissinger stated according to the newspaper 'Israel Hayom':

“In 10 years, there will be no more Israel”

Source: [http://www.israelhayom.com/site/newsletter\\_article.php?id=5907](http://www.israelhayom.com/site/newsletter_article.php?id=5907)

Too slowly we start to catch the magnitude of the lie, the diabolic trap designed for Israel, designed as it seems by the devil himself.

Who after all is pulling the strings, in which the Mossad got so terribly tangled up – putting the Jewish people in extreme danger?

# 25 Secret Societies

A secret society is nothing more but a tool for power.

- an instrument to control an institution without the institution knowing about it

Structure of Information inside a virus / inside the pyramid of power

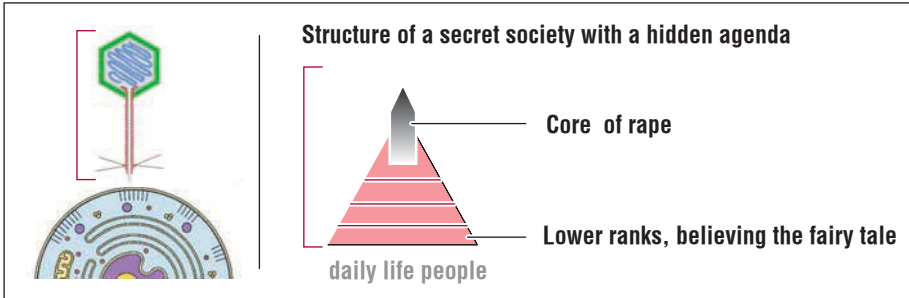

Source: [https://de.wikipedia.org/wiki/Bakteriophage\\_Lambda](https://de.wikipedia.org/wiki/Bakteriophage_Lambda)

The principle how a secret society corrupts a nation is:

- incredibly cunning
- incredibly advanced
- incredibly old

It is a copy from nature itself: bound to destruction by distorting information inside an organic structure:

- but little does a virus know about the lethal and self-destructive information it carries inside itself – people on top do

## The principle of control

“A crime chains people more effectively than virtue.”

To make a secret society work, people within the structure must be completely silenced, when they suddenly realize the true agenda.

How is this complete obedience achieved?

- it is achieved by **vicious crimes committed together**

## Examples for the Secret Agenda / the Core of Rape

- **CIA:** needed for US National Security  
– or just a part of **a drug running cartel** / part of a secret police?
  - **Mossad:** working for Israel's good  
– or just a **tool for the Armageddonists** to fuel Israel's incineration?
  - **Military Industrial Complex:** standing for safety and progress  
– or just **instigating war and destruction?**
  - **NASA:** opening space for the human race  
– or just **worshipping the dragon and the technology of destruction?**
- 
- **The Order of the Illuminati:** an attempt to make the rule of men over men obsolete  
– or just a **banker's tool** to overthrow the monarchies?

Founded on May 1st, 1776 by Adam Weishaupt the order aspired to the most noble purposes:

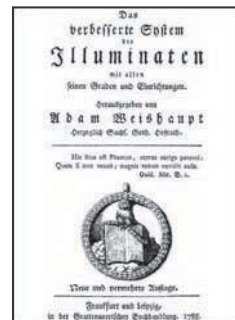

“To bring justice and peace to mankind. To make the rule of men over men obsolete. To create a just and free society.”

Source: <https://en.wikipedia.org/wiki/Illuminati>

However, Weishaupt was paid for his work by one of the most **powerful bankers** of that time – so perhaps the real purpose was:

“To make the rule of the king-men over men obsolete and put a banker-god in its place.”

Source: <https://en.wikipedia.org/wiki/Illuminati>

Weishaupt even wrote about it, the very first paragraph of his book about the order has the truth hidden in plain sight:

“Dear friend: you will be abused, you will be deceived”

Source (page 5): <https://archive.org/details/DasVerbesserteSystemDerIlluminaten>  
– Freund! du läufst Gefahr, gemisshandelt, gemisssbraucht zu werden –

# 26 The New World Order

President Woodrow Wilson wrote in 1913:

“Some of the biggest men in the U.S., in the field of commerce and manufacturing, are afraid of somebody, are afraid of something.”



“They know that there is a power somewhere so organized, so subtle, so watchful, so interlocked, so complete, so pervasive, that they had better not speak above their breath when they speak in condemnation of it.”

Source: <http://www.michaeljournal.org/articles/world-government/item/a-history-of-the-new-world-order-part-i>

## The New World Order is old

- to the greedy it comes in the cloak of monetary success
- to the patriots or religious it comes in the cloak of 'being part of the chosen people'
- to the environmentalist it comes in the cloak of 'love for nature'
- to the liberals and the young it comes in the cloak of permissiveness

## But the same force is behind it:

- **the decay of our values and our culture is deliberate!**

John F. Kennedy said in 1961 in his speech "On secret societies"

“For we are opposed around the world by a monolithic and ruthless conspiracy that relies on covert means for expanding its sphere of influence –”



“ – on infiltration instead of invasion, on subversion instead of elections, on intimidation instead of free choice, on guerrillas by night instead of armies by day.”

Source: <https://www.youtube.com/watch?v=y8HTr-F-FVM>

# The New World Order is a belief system of extreme supremacists

Its global agenda is currently unfolding, it manifests itself:

- by terror attacks like 9/11 or 7/7 in London as a symptom
- by secret societies and oligarchs as a tool for power
- by a mad, hidden – but well structured agenda
- by the **worship of evil as the real [and spiritual] source of power**

## The four power levels of the New World Order

	<b>4. luciferian level: spiritual-technological doctrine / hate against the living beautiful and just</b>		
	<b>3. dark state level: profit by abuse</b> [power&perversion oriented; money printers]		
	<b>2. deep state level: deception</b> [money oriented / big corporations / war machine]		
	<b>1. state level: complete ignorance or confusion</b>		

Source: <https://en.wikipedia.org/wiki/Illuminati>

Who would believe that this is an official NASA mission pad?

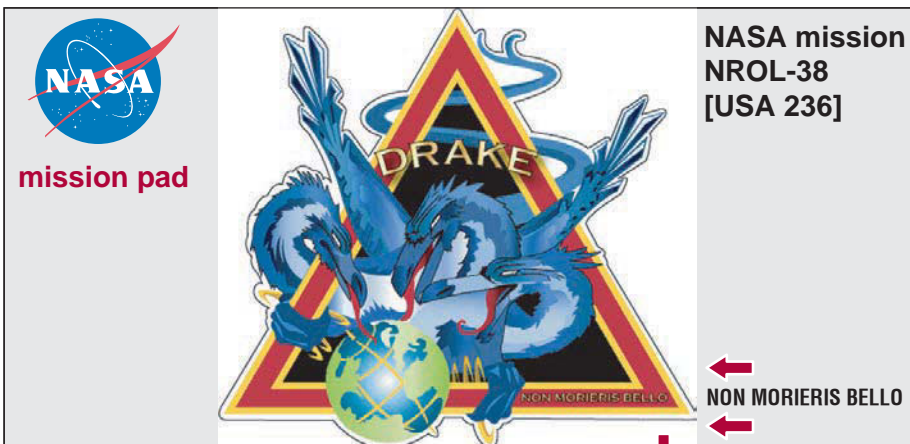

Source: [https://en.wikipedia.org/wiki/List\\_of\\_NRO\\_launches](https://en.wikipedia.org/wiki/List_of_NRO_launches)

NON MORIERIS BELLO translates: **you will not have a nice death.**

## 26 Symptoms of the disease

Sergey Lavrov, 2017: the post-Christian period of the West

“If we talk about Western and European values, which are constantly put forward as example for us, these are probably not the values the grandfathers of today’s Europeans espoused but something new and modernized, a free-for-all, I would say”

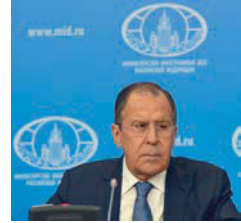

“These are values that can be called post-Christian.”

[www.mid.ru/en/foreign\\_policy/news/-/asset\\_publisher/cKNonkJE02Bw/content/id/2599609](http://www.mid.ru/en/foreign_policy/news/-/asset_publisher/cKNonkJE02Bw/content/id/2599609)

### What is this "new post-Christian" in our society?

- destruction of freedom / destruction of free choices (enslavement by interests on debt of virtual money and addiction to consumption)
- destruction of the family
- destruction of the male / female (destruction of gender identity)
- destruction of national states **including the US and Israel**
- destruction of cultural identity and humanistic education (mass immigration)
- abolition of cash money
- limitless creation of virtual money by the private banks (fiat credit money)
- absolute obedience to the ruling power elite
- terror management and terror attacks against civilians (including nuclear and chemical attacks)
- mandatory RFID chip implants in humans
- educated to become greedy / create a monetary based reward system without love
- despise of human life (e.g. embryos as objects or bred as organ donors)
- despise of god's creation
- sexual perversion / sadism
- destruction of the spiritual self identification (all religions)
- glorification of symbolic and direct violence



# 26 Dancing with the devil

The perfect devilish lie is achieved by telling the truth, while deceiving the victim fatally: **categories of 9/11-deceptions / 911-lies**

**David Cameron**

**Inverting the truth as being impossible**



“We know this world view.”

“The peddling of lies: that 9/11 was somehow a Jewish plot or that the 7/7 London attacks were staged.”

Source @00:28: <https://www.youtube.com/watch?v=0g-HqRP-ANK>

**Christie Whitman**

**Deception by omission / not having carried out s.th**



“We didn’t find harmful substances.”

“The air if safe to breathe”

Source @00:33: <https://www.youtube.com/watch?v=BxdtttHY59b4>

**Barack Obama**

**Deception by shifting the event in time**

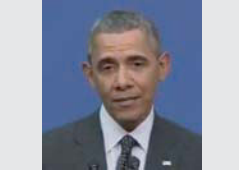

“I continue to be much more concerned about – when it comes to our security – with the prospect of a nuclear weapon going off in Manhattan”

Source @35:16: <https://www.youtube.com/watch?v=L2AGIWe2JJE>

**Michael Bloomberg**

**Deception by citing secret knowledge\***



“... you created order, order out of chaos”

**\*) Motto of freemasonry**

Source @00:59: <https://www.youtube.com/watch?v=TRN2Pch7gQg>

**Shyam Sunder**

**Deception by giving false testimony**



“World Trade Center 7 collapsed because of fires fueled by office furniture.”

“It did not collapse from explosives or from fuel oil fires.”

Source @00:22: <https://www.youtube.com/watch?v=8AYPvwJk0q0>

# 27 Time and education

## 26.1 The discovery of slowness

“But time is life.  
And life resides in the human heart.”

“And the more people saved,  
the less they had.”



Source: *Michael Ende, MOMO, end of chapter 6*

## 26.2 About the education of the masses and the A-bomb

“In this lies our only security and our only hope – we believe that an informed citizenry will act for life and not death.”

**Albert Einstein (1879 – 1955); on atomic energy**

Source: [www.ratical.org/radiation/KillingOurOwn/KOO.pdf](http://www.ratical.org/radiation/KillingOurOwn/KOO.pdf)

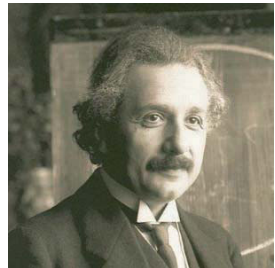

## 26.3 About the education of the masses and liberty

“Educate and inform the whole mass of the people... They are the only sure reliance for the preservation of our liberty.”

**Thomas Jefferson (1743 – 1826, American President)**

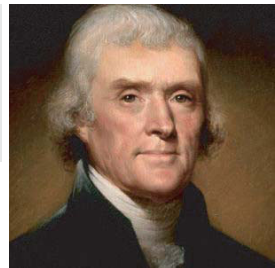

Source: <https://www.brainyquote.com/quotes/quotes/t/thomasjeff135368.html>

## 26.4 Knowledge is our power

As monstrous as the evaporation of three thousand people in New York was, as appalling it is to know that tens of thousands will die of cancer needlessly by treason alone, one thing above all will remain unconceivable to the world:

- the stupidity of the crime

How is it that a small group of neo-fascist zionist criminals is able to take the entire world hostage?

- it is by **our consent**, based on disinformation

These crimes will not stop, as long as the creation of money resides in the hand of powerful criminals and their private banks.

However, if we – as a people – stop to cooperate and start to expose the system it will crumble by itself.

On a **personal level** we can simply try to resist the agenda:

- to defend our freedoms
- to hold our family in high esteem
- to prevent indoctrination of false gender identity
- to defend our national state and our culture
- to use cash money or other means of exchange
- to refuse the RFID chip implants agenda
- to laugh at the ruling power elite, to make them afraid of us, by the knowledge we hold
- to take life as something sacred – and to know our spiritual self

So let me finish my presentation with the words I used at the beginning.

We are in this together. Truth, justice and peace are the only option. For all of us.

To disarm the devil – and not to serve him.

# 27 Questions & Answers

## Q1: how did they control radioactivity?

The chosen tactics was: "controlling the controllers". Over 4,000 first responders and policemen were equipped with small detectors:

- any sort of alarm would have been under the system's control

In addition, radioactivity levels outside the WTC area were most likely quite low because of:

- a minimized primary (fission device for ignition)
- absorption of the radioactivity in the pit (the rockbed below)

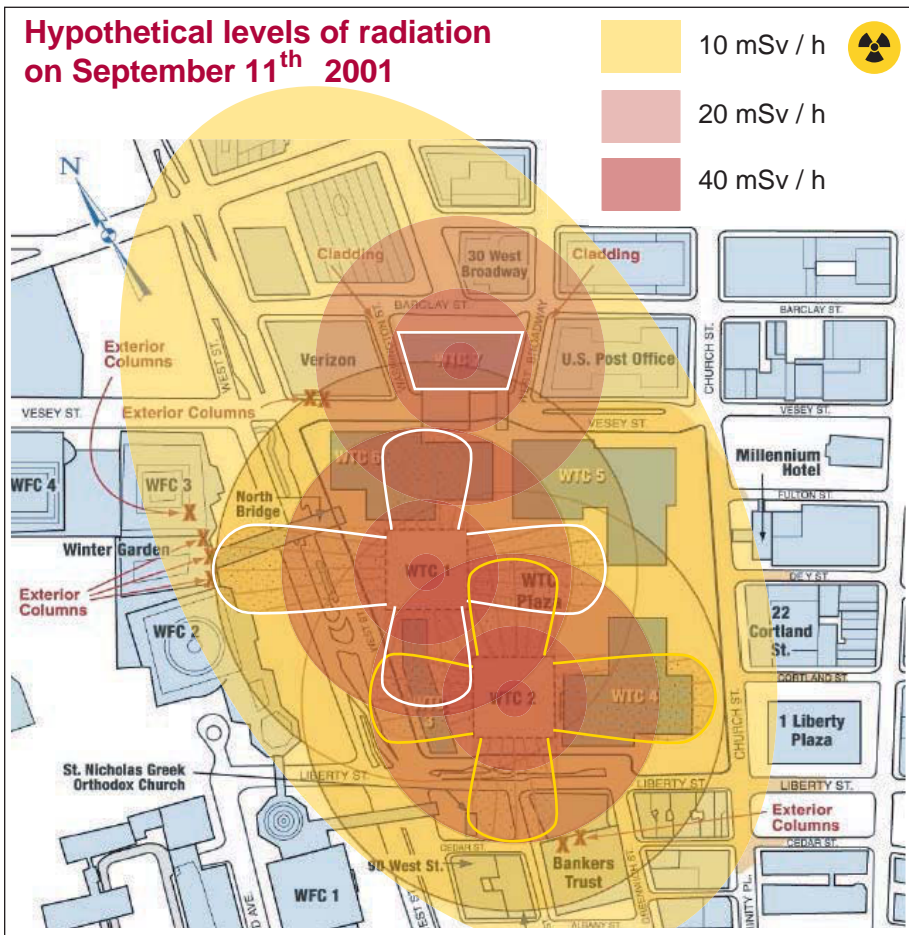

Source (modified): <http://911research.wtc7.net/wtc/analysis/collapses/mushrooming.html>

## Q2: to what extent Israel is responsible?

Even if Israel [or the neocon-fascist Zionist supremacists behind it] can be regarded as the driving force, part of the responsibility lies certainly also in the "western power structure".

There was too much conformity, too much collaboration, too much profit in the West and for the "western elite".

I would call it a joint venture operation, a fifty-fifty business of the bankster cult and the military-industrial complex.

### Benjamin Netanyahu interview, NBC, 9/13/2001



"I said if we don't arrest the militant [...] then the next thing that will be is not a car bomb in the World Trade Center, but a nuclear bomb"

**Benjamin Netanyahu**

Source @ 00:27: <https://www.youtube.com/watch?v=GAhtATuljPM>

He continues:

"Now, it wasn't a nuclear bomb, it was a 350 ton conventional bomb"

Indeed, the Twin Towers' shockwaves correspond to:

- a 0.35 kt primary ignition charge (exempt the slow fusion burn, which added to the yield through radiation)

## Q3: what kind of tests have been made?

Already old [declassified] military film show systematic testing:

- steel structures, bridges, buildings were exposed to nuclear blasts (from below and above ground)

### Nuclear Test: "Operation Upshot-Knothole" (1953)



Source @ 09:55: <https://www.youtube.com/watch?v=r9UwBOhyJSI>

#### Q4: how could people survive the blast inside the Tower?

A small group of people survived the blast, being trapped on the fourth floor inside the North Tower.

This "Miracle of Stairwell B" is often cited to refute the hypothesis of a nuclear blast: they would be all dead.



Source: <https://www.google.com/maps/@40.7091124,-74.0100864,16z>

However, if these people were never exposed to the nuclear blast, the picture changes completely.

The required eruption channel for the nuclear plasma must have a size of only approx. 12 m x 12 m:

- equivalent to the size of the central cavity of the "Memorial Pools"

This is like standing next to a machine gun, firing up:

- if you are standing a few meters aside from it, you go unharmed



## Q5.1: what temperature was reached inside the Towers?

Temperatures well over 1,000,000 °C are achieved in the centre of a nuclear burn.

However, these extreme conditions are limited to the tiny space where the nuclear burn takes place.

- the nuclear plasma exits the rockbed with only 8,000 °C
- the upshot is very focused and limited to the building's core
- the pressure wave is also directed upwards, as if exiting a nozzle

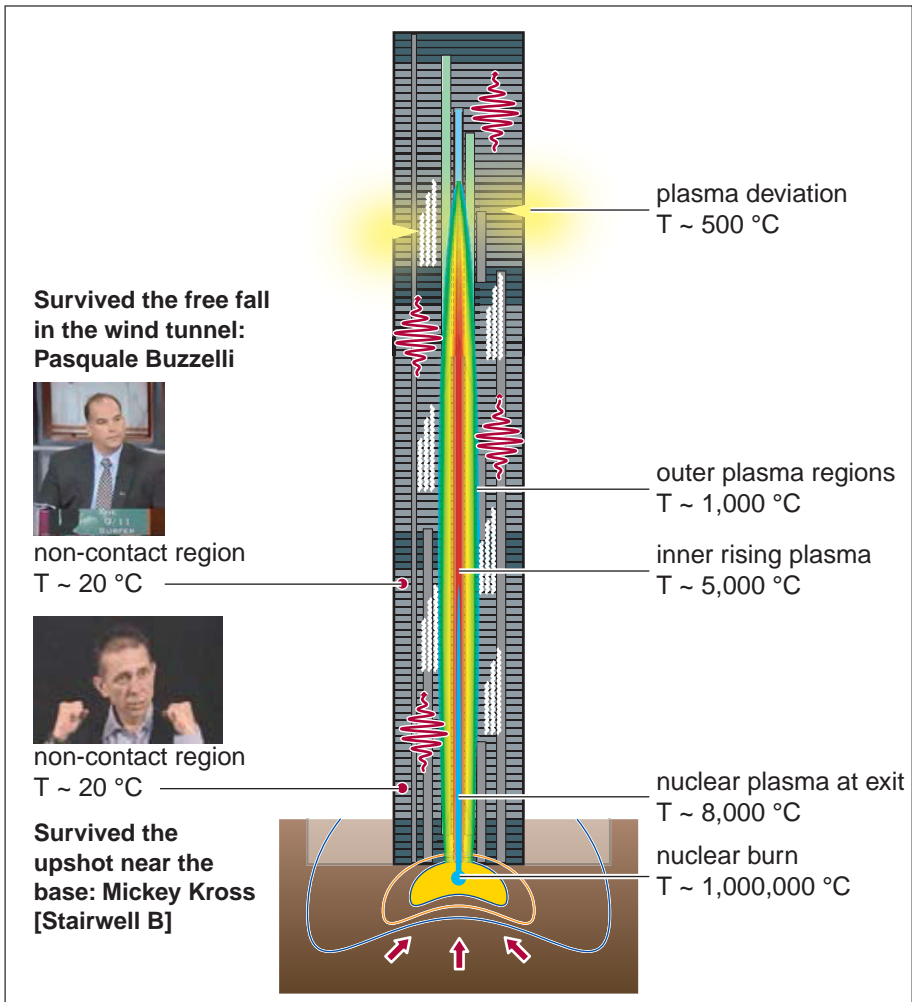

Source (modified): <https://wikispooks.com/wiki/File:SkyScrapersScheme.jpg>

## Q5.2: are the findings of ae911truth.org invalidated?

The findings of the group 'Architects&Engineers for 9/11 truth' are still valid in respect to the key evidence, but missing are at least:

- calculation of the overall energy involved [terajoules]
- interpretation of the momentum of the entire process (indicating one single source of energy – the rising and falling wave)

### Valid key evidence – collected by ae911truth

- numerous accounts of pre-collapse explosions
- rapid onset of destruction
- acceleration through what should have been the path of greatest resistance
- isolated explosive ejections 20 to 60 stories below the “crush zone”
- lateral ejection of multi-ton steel framing members distances of 200 m
- mid-air pulverization of 90,000 tons of concrete
- large volumes of expanding pyroclastic-like dust clouds
- total destruction and dismemberment of all three buildings
- several tons of molten steel/iron found in the debris piles
- evidence of thermite incendiaries on steel beams / diagonal cuts
- nanothermite composites and iron microspheres found in WTC dust samples



the famous diagonally cut columns

Source (modified): [http://666ismoney.com/911\\_Fraud.html](http://666ismoney.com/911_Fraud.html)

Workers inside the South Tower's remains, on Oct. 27, 2001.



Source: [http://archive.boston.com/bigpicture/2011/09/ground\\_zero\\_september\\_11\\_2001.html](http://archive.boston.com/bigpicture/2011/09/ground_zero_september_11_2001.html)

Huge parts were spread over the area: workers on site, Sept. 28, 2001.



Source: [http://archive.boston.com/bigpicture/2011/09/ground\\_zero\\_september\\_11\\_2001.html](http://archive.boston.com/bigpicture/2011/09/ground_zero_september_11_2001.html)

### Q5.3: how was the melt out of the buildings achieved?

As the presence of the incendiary thermite was confirmed in the dust samples, the pre-collapse melt out was most likely done using this sort of highly reactive substance.

However, theoretically the weakening of the inner core could also be achieved by a small research reactor (if it was already installed):

- highly critical reactors would be able to produce multiple radiation pulses

#### Example: test reactor Borax II in supercritical condition



Source: <http://www.ne.anl.gov/About/reactors/lwr3.shtml#fragment-5>



In the US, a number of reactors were run supercritically and blown up deliberately for test purposes.

After the neutron control rods had been catapulted out of the fuel elements, the whole reactor exploded as expected.

### **Example: test reactor Borax II during explosion**



Source @13:58: <https://www.youtube.com/watch?v=8WfNzJVxVz4>

William Tahil, the author of the book 'Ground Zero: the nuclear demolition of the World Trade Center', is convinced that a pulsed nuclear reactor or an enhanced radiation weapon was already built-in, in the sub-basement of each Tower.

The mindset of the perpetrators is certainly open to everything, even blowing up a nuclear reactor, by self-destruction or by triggering an additional nuclear weapon beneath it.

However, I do not believe it, simple because contamination levels would have been much higher and easily detectable.

## Q6: do the seismic shockwaves indicate a nuclear process?

Underground explosions can be easily distinguished from an earthquake, as the different waveforms are scattered in a unique pattern.

The 9/11 signal clearly indicate an underground explosion, however surprisingly small in magnitude for a nuclear weapon:

- this indicates that only part of the energy was released as a shockwave, a sort of additional slow-and-powerful radiation device was therefore involved
- alternatively, this might indicate a very poor coupling of the energy in the ground (due to damping factors)

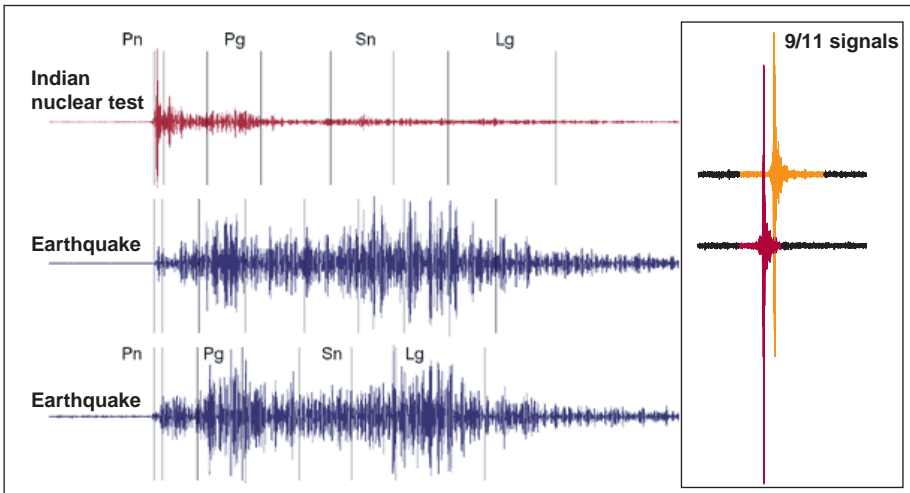

Source 1: <https://str.llnl.gov/str/Zucca.html>

Source 2: [http://www.ldeo.columbia.edu/LCSN/eq/20010911\\_WTC/WTC\\_LDEO\\_KIM.pdf](http://www.ldeo.columbia.edu/LCSN/eq/20010911_WTC/WTC_LDEO_KIM.pdf)

## Q7.1: how does nuclear fission start?

The atom splits in two, if one neutron hits the tiny nucleus directly.

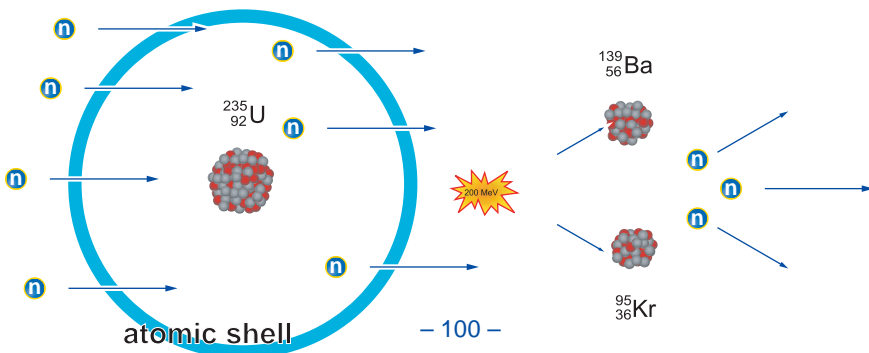



## Q7.2: how did they minimize the critical mass / the fallout?

Critical mass means first of all:

- sufficient neutrons per cross section to get most of the uranium atoms hit on the nucleus directly and simultaneously

As the nucleus is very tiny and a direct hit is unlikely, growth factor is normally much smaller than 1: the process stops

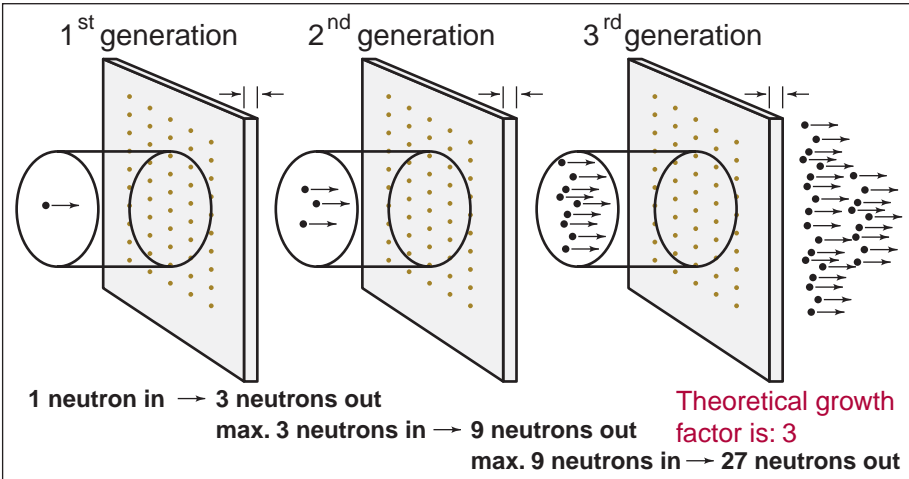

Source (modified): <http://hyperphysics.phy-astr.gsu.edu/hbase/Nuclear/crosec.html>

Only if the initial number of neutrons is already very high, the critical threshold can be passed:

- growth factor  $> 1$  leads to an explosion

The 16 kt yield atomic bomb which incinerated Hiroshima in 1945 carried 64 kg uranium-235 of which only 0.91 kg were consumed.

Critical mass of uranium-235 is:

- 50 kg, unaided
- 17 kg, with a simple 30 cm iron housing for neutron reflection

Source: [https://en.wikipedia.org/wiki/Critical\\_mass](https://en.wikipedia.org/wiki/Critical_mass)

To what degree critical mass can be reduced by using artificial neutron radiation sources, extreme compression, optimized geometry and powerful neutron reflectors is a military secret, however:

- if neutron flux could be fully targeted, theoretically 1 kt yield would require: **56 g of uranium-235**

## Q8: why did concrete blocks transform to dust at free fall?

Once the water inside the concrete crystal absorbed the radiation energy and turned to overheated steam it ripped the crystal apart:

- from that point on the concrete blocks were as brittle as a dry sand castle thrown into the air

The nuclear radiation did NOT destroy or influence the concrete blocks during free fall: destruction was already done.

## Q9: is there real proof for an additional nuclear fusion?

yes: if the yield was the output from a first generation nuclear fission device alone, radioactive contamination would have been extreme:

- although the presence of the expected elements was confirmed in the dust, no information about isotopes [and thus origin] was given

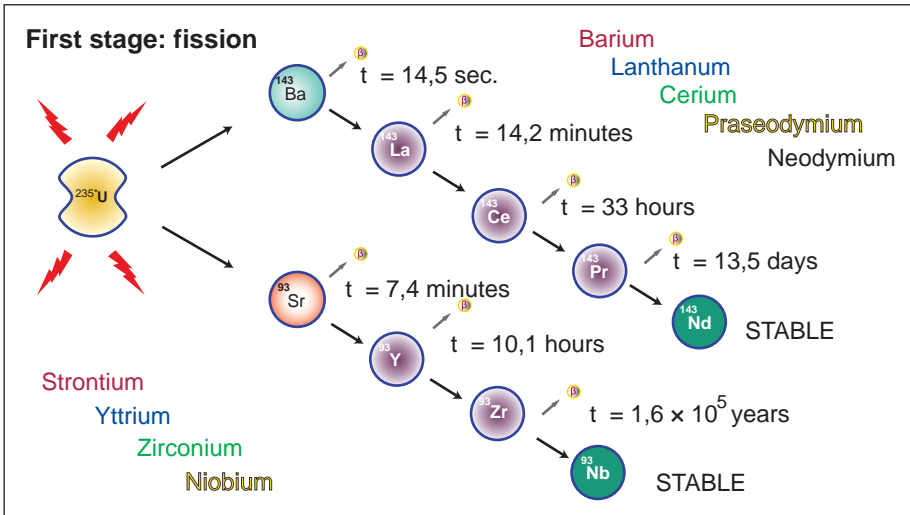

Source (modified): <http://www.nndc.bnl.gov/chart/reCenter.jsp?z=56&n=87>

In fact, elevated levels of the nuclear fusion fuel tritium  $^3\text{H}$  were found.

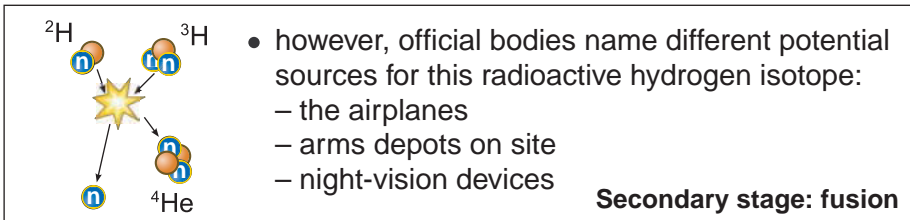

Source: <https://e-reports-ext.llnl.gov/pdf/241096.pdf>

## Q10: how reliable are the findings of Prof. Dr. Steven Jones?

In 2006 Prof. Dr. Steven Jones published a letter, emphasizing:

- no traces of radioactivity were found [ 5 years after the event ! ]
- no extreme pulverization of the towers took place, they disintegrated mainly into small chunks

### Hard Evidence Repudiates the Hypothesis that Mini-Nukes Were Used on the WTC Towers



Letter, by Dr. Steven E. Jones

28 Sept 2006 (Updated Jan. 2007, peer-reviewed, accepted for publication 7 Jan 2007. Appendix A added 16 January 2007.)

Source: <http://www.journalof911studies.com/letters/a/Hard-Evidence-Rebudiates-the-Hypothesis-that-Mini-Nukes-were-used-on-the-wtc-towers-by-steven-jones.pdf>

Given the scope of the crime, having just one reference point and just one analysis from one professor – although with good intentions – is not what I would call "being on firm ground":

- needed are several independent teams of international experts to analyze the rockbed below the Memorial Pools

"As we examined the WTC-debris sample, we found large chunks of concrete (irregular in shape and size, one was approximately 5cm X 3 cm X 3cm) as well as medium-sized pieces of wall-board (with the binding paper still attached). Thus, the pulverization was in fact NOT to fine dust..." Prof. Dr. Steven Jones

## Q11: how many people died on 9/11?

Due to the crime on 9/11 about:

- 3,000 people died instantly in the towers
- 2,000 people already died of cancer [2017]
- 5,400 people are currently sick with cancer [2017]
- millions of people were killed in the wars that followed

## Q12: how were the caverns under the WTC created?

An analysis of photos and satellite images shows clearly:

- the locations of the registered hotspots matches the location of the potholes / channels

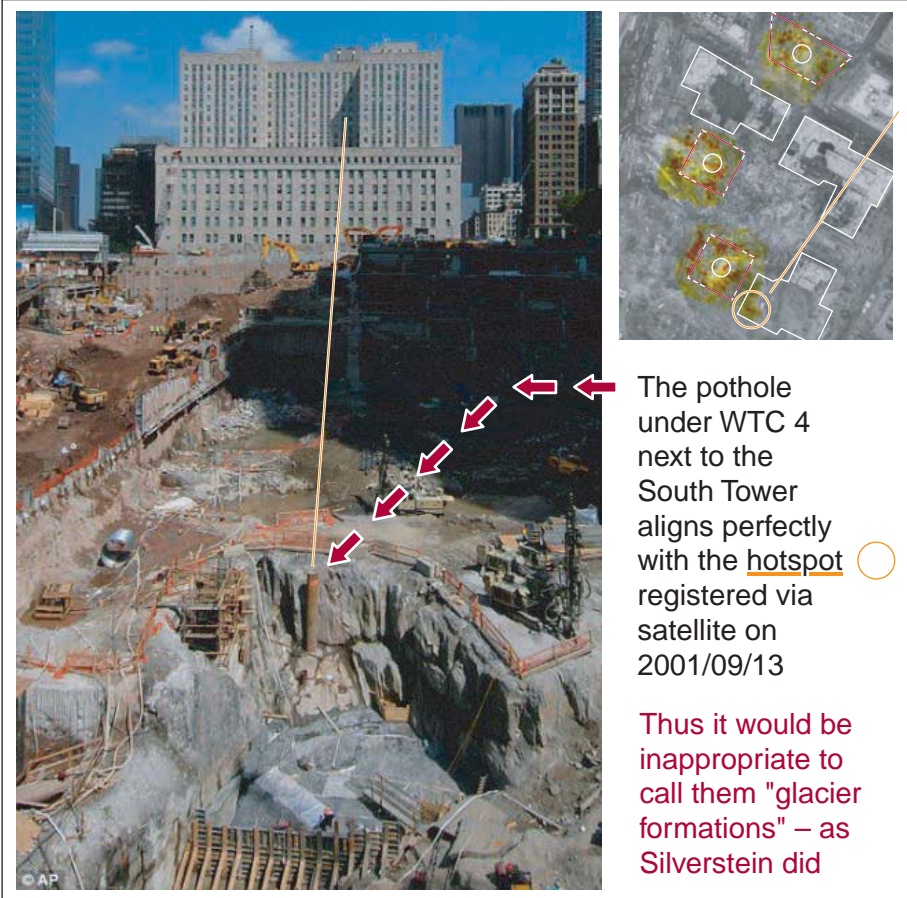

Source 1: <http://www.nytimes.com/2008/09/22/nyregion/22rocks.html>

Source 2: [http://911research.wtc7.net/papers/dreger/GroundZeroHeat2008\\_07\\_10.pdf](http://911research.wtc7.net/papers/dreger/GroundZeroHeat2008_07_10.pdf)

**SILVERSTEIN**  
PROPERTIES

- Silverstein's video shows the "surprise" findings of caverns below Tower 4 / Tower 2  
The "glacier formations" were "not noticed" in 1967 when the The Bathtub was built down to bedrock (20 m below shoreline)

Source: [https://www.liveleak.com/ll\\_embed?f=a01\\_1226984195](https://www.liveleak.com/ll_embed?f=a01_1226984195)

1. An upwards reflected particle/photon beam will, first:

- focus the number of particles/photons in the surface region

Like a reflecting lampshade reflects light to the ceiling, some part of the radiation energy of a nuclear weapon can also be directed upwards

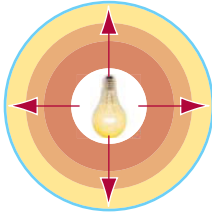

Photon pulse without reflector

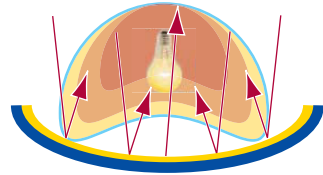

Photon pulse with reflector

Source: [https://en.wikipedia.org/wiki/Stopping\\_power\\_\(particle\\_radiation\)](https://en.wikipedia.org/wiki/Stopping_power_(particle_radiation))

2. An upwards reflected hard particle beam will, second:

- release most of its energy at its stopping point (Bragg peak)

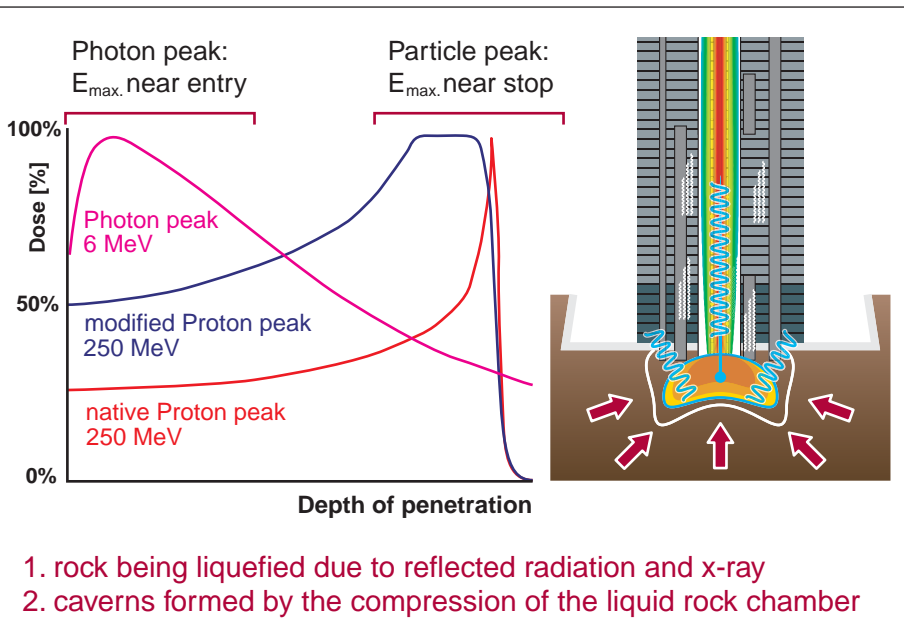

1. rock being liquefied due to reflected radiation and x-ray
2. caverns formed by the compression of the liquid rock chamber

Source: [https://en.wikipedia.org/wiki/Bragg\\_peak](https://en.wikipedia.org/wiki/Bragg_peak)

## Q13: how were the nukes placed under the Towers?

Most likely the device was placed directly under the freight elevators as:

- the mechanical shockwave of the nuclear weapon was very small
- the secondary reflected radiation was the main source of destruction, so the weapon could be placed relatively NEAR the surface

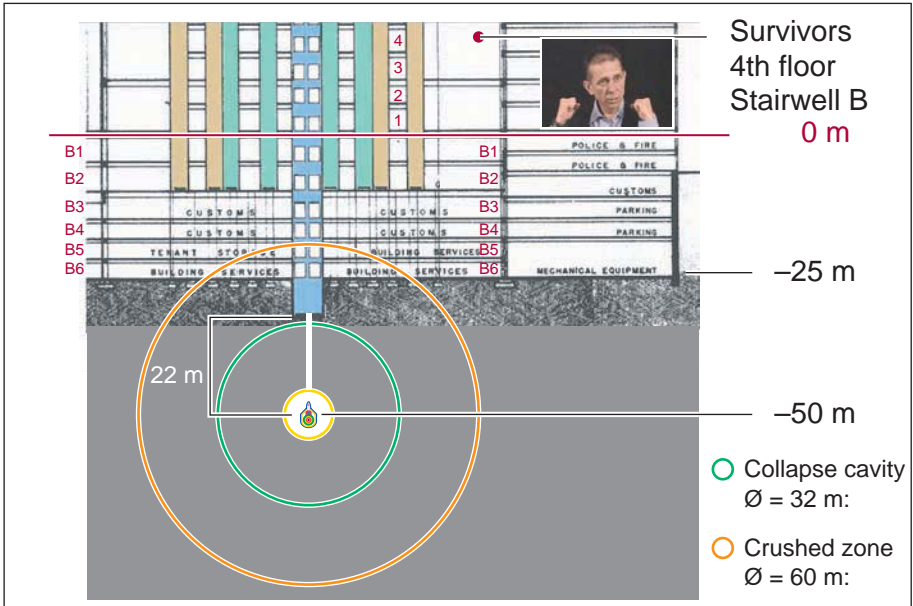

Source: <https://jamesperloff.files.wordpress.com/2016/11/elevators-chematic.png>

- alternatively an already existing underground tunnel communication system was used to bring the device into position

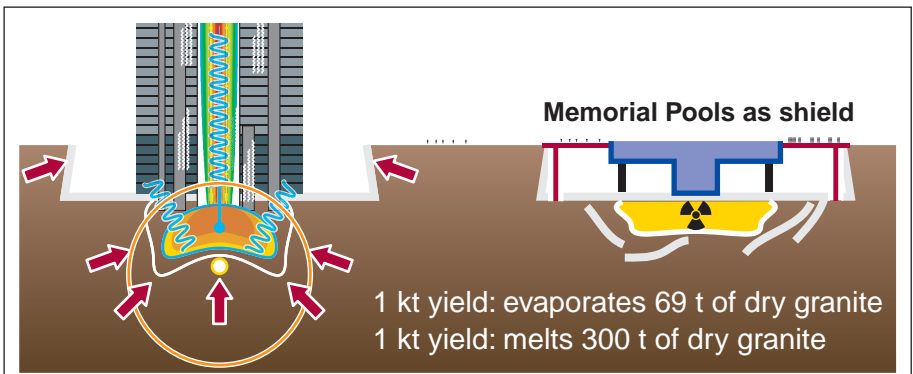

Source (1 kt yield: USGS, page 19): <https://pubs.usgs.gov/of/2001/0312/report.pdf>



## Q14: who or what controls the Secret Societies?

In the end it is irrelevant what ethnic group or sect or power structure is behind these secret organizations:

- it leads to a psychopathic, phobic and criminal mindset

I can't tell who is on the very top, but as Shakespeare put it:

“Though this be madness, yet there is method in 't.”

### The need for perpetual war

There is a distinguishable method in instigating our wars, and currently all leads to a war between Israel and the Muslim world.

The destruction of Israel is not in the interest of the neocon-fascist zionist supremacists – and yet: the method applied leads to it.

Most likely the zionist are simply played by other powers, name them Armageddonists, Luciferians, Freemasons – or Sheitan.

### The need for idolism and glorification

Remarkably, there seems to exist a constant need for portraying and idolizing a set of symbols, namely:

- the One Eye / the Serpent's Eye
- the Masonic Pyramid
- the Globalists' Star with the Pentagram

The One Eye is constantly repeated as a 9/11 symbol in NewYork



Source 1 (NYC Subway Station): <https://www.youtube.com/watch?v=1GIFHfpZ6m8>

Source 2 (2002-09-11): [https://www.youtube.com/watch?v=DY7zx1VXC\\_0](https://www.youtube.com/watch?v=DY7zx1VXC_0)

## Examples of having the One Eye worshipped on Ground Zero

### Formation of the One Eye on 2002/09/11 and 2008/09/11



<http://elizabethavedon.blogspot.de/2014/06/james-estrin-oprahs-super-soul-sunday-tv.html>  
[http://archive.boston.com/bigpicture/2011/09/ground\\_zero\\_september\\_11\\_2001.html](http://archive.boston.com/bigpicture/2011/09/ground_zero_september_11_2001.html)

This addiction to symbolism leads to a philosophical question:

- does the devil exist as a real and spiritual entity?
- or – does the human being create this evil just by believing in it?

### Completion of the train station Oculus: above and below ground



Source 1: [https://en.wikipedia.org/wiki/World\\_Trade\\_Center\\_station\\_\(PATH\)](https://en.wikipedia.org/wiki/World_Trade_Center_station_(PATH))  
Source 2: <https://www.youtube.com/watch?v=1GIFHfpZ6m8>

In any case we can identify a very small group of people involved:

- worshipping an evil deity through symbolism and action

How they could achieve this power is now in the open:

- through control of the monetary system

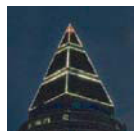

For what reason these powerful people turned to a self-destructive spiritual philosophy remains unknown.

## Examples of strange symbolism in our institutions

The Pope sits at Center of a Snake's Mouth in Paul VI Audience Hall

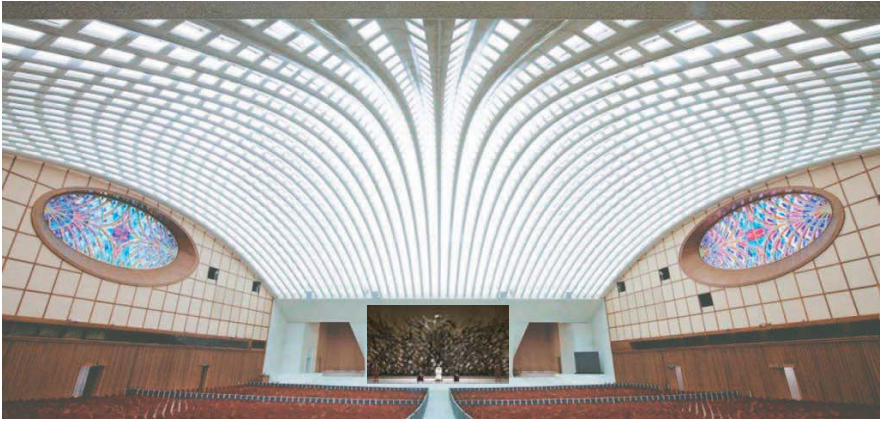

Source 1: <http://i.imgur.com/bbcKLRm.jpg>

Source 2: <http://i.imgur.com/5WCsSlu.jpg>

Identifying the NWO symbols, used by NASA

- the diamond-dragon's prey / the eye of the snake



Source: [https://en.wikipedia.org/wiki/List\\_of\\_NRO\\_launches](https://en.wikipedia.org/wiki/List_of_NRO_launches)

## 27 A story from Stansted Airport

I arrived well in time, 2 h 15 min before my plane's departure.

Passing directly to the security proceedings I lined up, together with the crowd, getting to the appointed section.

The played music was unpleasant during these first minutes: loud, penetrating, annoying.

The stupid proceedings went on as usual: the to-be passengers walking in socks through the detector gate, causing the normal congestion while taking the shoes back on.

One sad, detestable and disgusting picture I remember, if one makes the correct connection: a boy, about five years old, trying to hold his arms up.

Standing inside the full body scanner box the boy just didn't get it right. The officer wasn't pleased with the result, not unfriendly – but insisting.

So, "hands up" it was, right behind the neck: a would-be Pulitzer prize picture if it was shot in the right angle, making the connection to the historic photograph – the terrified jewish boy holding his hands up and the SS officer with his rifle in the background.



Source: [https://en.wikipedia.org/wiki/Warsaw\\_Ghetto\\_Uprising](https://en.wikipedia.org/wiki/Warsaw_Ghetto_Uprising)

No joke to me, however the boy only feeling awkward, the parents smiling.

I had luck: I passed the detector gate without triggering a signal. Would I have refused to enter the body scanner? I doubt me, but angry I was.

I was less lucky with my hand-luggage, as expected: it got sorted out. Much too much electronics inside, the micro, the speakers and all my special presentation equipment.

When my hand-luggage arrived for second inspection, I did not expect something unusual: friendly words and an additional routine check, as it was before in Germany.

I opened the hand-luggage and knew I was in trouble: right on top it was: Jim Fetzer's and Nick Kollerstrom's fatal book:

- **America Nuked on 9/11**

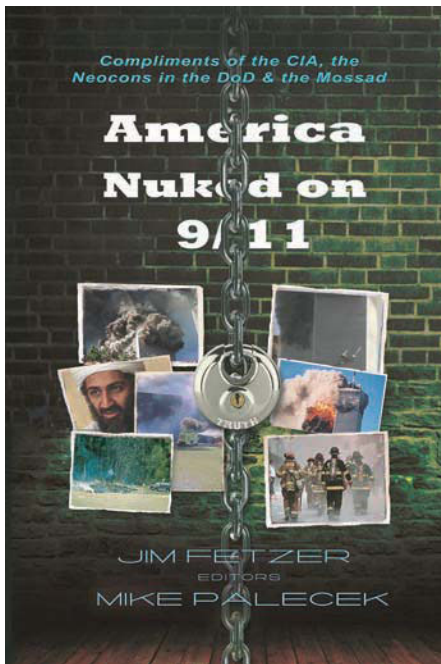

Compliments of the CIA, the  
Neocons in the DoD  
& the Mossad

**America  
Nuked on  
9 / 11**

by Jim Fetzer

Source: <https://www.amazon.com/America-Nuked-11-Compliments-Neocons/dp/0692756108>

The lady stiffened, staring at the book in disbelief. Touching it as if it was an object with some dark power.

Turning the book round, back and forward, reading the title several times, as if it could change before her eyes.

Then she called the armed airport security by phone.

Being now a "security issue" with two polite armed guards standing by, I was questioned by the lady: my outgoing flight, my purpose of my visit to London.

Then she asked:

- whom do you work for?  
– I replied that I was self-employed.

To my surprise, she barked back:

- can you prove it?

This was unexpected.

I could not prove my status and my money sources, I was interested in getting on my flight.

I understand now: she was specially trained. Clearly trained to look for these keywords. 9/11. Or Nukes. Or Jews. Or Israel. Or Mossad. Or Osama bin Laden.

One key-word already would have guaranteed me a special treatment.

But Jim Fetzer's book provided them ALL: it was too much for the lady. Nervous she was.

The guards flipped through my printout-papers listlessly.

Finally they decided to inform the airport intelligence.

Meanwhile I had to empty the entire hand-luggage, the lady seemed eager to slit it open, searching for hidden pockets, which could hold the "razor blades".



An additional test of explosives took place, wiping my suitcase with a sort of small tissue, which was then put into the machine for molecular trace-analysis.

I braced myself to miss my plane, as being much likely, as we were waiting for the intelligence to arrive, ten minutes or so.

As I didn't carry anything more dangerous than a book, the two arriving intelligence officers sent the armed guards away, inviting me to a personal talk, "just to know more about you on a personal level".

No unfriendly words.

And so I found myself in a small, windowless interrogation chamber, only a few meters away from the original checkpoint.

They were polite enough to check my departure-time and my plane, indicating they were not interested in holding me too long.

And so I had the pleasure to pass about 30 minutes or so in the room for special guests, giving my second lecture on the 9/11 topic to the intelligence officers.

And yes, they took notes, handwritten.

- where did the meeting take place?
  - I showed the Diorama address, clearly visible on my printouts:  
nothing to hide
- whom were you talking to?
  - I showed the 911keptalking printouts, addresses written down
- did they ask you to present this topic?
  - I denied, it was me who applied to 911keptalking
- why did you engage?
  - I replied, I felt it was my civic duty

- what was the audience's reaction?

- I wanted to describe it as:

- # highly interested

- # surprised

- # thankful on a personal level

- # generous

... but I was interrupted by the next question, crossfiring.

- who did contact you?

- I repeated, I contacted 911keep talking myself

- why do they write you were a nuclear physicist, how much 'nuclear'?

- I replied, the title was chosen as it certainly sounds good, pointing out that my job was in the field of technical documentation, not in the nuclear weapon industry

They agreed, smiling on the joke.

- are you employed?

- I repeated [again, and at this point wondering how important the money issue was for the security], that I was self-employed, having different customers

Should an employed person be afraid in naming his employer?

Afraid of losing his job? Getting into trouble because of a free lecture?

I can't guess.

- where do you live?

- I showed my papers, writing my home address down for them

- do you own a mobile phone?

- I denied, I could not give a number, carrying only my wife's mobile phone for this trip

- why don't you have mobile phone of your own, are you afraid to be wiretapped?
  - I replied, I would not exclude it – but living without a mobile was a convenient lifestyle anyway
- are you a religious person?
  - I denied
- spiritual?
  - I replied, I would accept this term, without insisting or further specification
- do you earn money by your 9/11 talks?
  - I denied, it was a ruinous business
- why do you have so many russian visas in your passport?
  - I replied, my wife was Russian

At this moment the situation changed. I dropped out for them, becoming an object. The conversation was no conversation any more, but a discussion between the two.

The younger officer suggested twice taking copies of all russian visas.

The elder officer in charge dropped it:

" – ... "his" wife is russian, and so: no need for investigating this."

Then I dropped in again: the unequal "conversation" continued between us three:

- did you go to New York after the attacks?
  - I denied, I was in New York only two years before the event
- so you never saw the museum?
  - I confirmed, for me the official site [911memorial.org](http://911memorial.org) was a scandal, causing me to create the website [911memorial4kids.org](http://911memorial4kids.org)

The younger officer engaged, most likely sincerely:

"I saw it. I was there, it is the documentation of a crime.

I was on firm ground, relaxing.

Replying there are many theories outside, Richard Gage, the Russian serviceman Dimitri Khalezov, Dr. Judy Wood and the engineer William Tahil.

Around these four centres of gravity the belief system of the different groups was rotating in a space of ignorance.

The officer in lead gave me credit, he agreed. We also noted that Dr. Judy Wood's theory is a bit far fetched.

Star wars space weapons do not exist, yet.

- so how was it done, in your opinion?
  - I mentioned the possibility of containing a nuclear blast in the rockbed, the guided neutron flash from below and the following, nearly soundless eruption

Again the younger officer heated up:

"The towers were build on a landfill, I know it, I have seen it, it is documented."

"In no way the landfill could have contained the blast. I saw it in the museum".

"You might take a normal cloud for a mushroom cloud – if seen from below and in your own imagination, as a misinterpretation of some pictures."

I apologized, not excluding mistakes from my part. Trying to resist the temptation of holding a lecture with the material I had on the laptop.

Time was passing by. My plane would not wait.

- do you think the government is controlled by non-legal powers?
  - I replied I would not exclude it, as big corporations and banks hold the real power
  
- your papers mention 7/7, was this part of your talk?
  - I replied, that 7/7 was not my topic, but one comes across it when analyzing 9/11
  
- do you think that the government did 7/7?
  - I replied it would fit the picture

Once again the situation changed. They clearly disliked my response.

9/11 did concern the US, 9/11 was far away, a joke.

As for 7/7 in Britain: they took it seriously.

- do you think we created ISIS?
  - I replied it would fit the picture
  
- what do you mean, creating it by instigating hate due to political errors – or funding it?
  - I replied we can be sure ISIS is funded by the West



Clearly in discontent the younger officer replied defiant, reproachful and nearly indignant: "This is your belief!"

The older officer in charge calmed him down: "no need to get angry. "He" is free to speak."

"He" – that's me. We returned to 9/11. Politely.

- is this all YOUR own material?
  - I showed what was given to me by the audience. Including the red book from the "Ministry of Peace":  
9-11 – THE ISRAELI LINKS (which they did not like)
- what is your website?
  - I wrote down the [www.911history.de](http://www.911history.de) – nothing to hide
- do you think there is a global agenda behind it all?

Suddenly I felt being in the position of the questioner, asking with a smile: "certainly you have already heard of the New World Order?"

	<h2>The Serpent's Eye</h2>	
<p>Logo of Skull&amp;Bones</p>		
<p>versus</p>		
<p>Logo of the Carrier Strike Group 5</p>		
<p><b>The One Seeing Eye of the Order: pillage, rape, murder and death</b></p>		

Source 1: [https://en.wikipedia.org/wiki/Skull\\_and\\_Bones](https://en.wikipedia.org/wiki/Skull_and_Bones)

Source 2: [https://en.wikipedia.org/wiki/Carrier\\_Strike\\_Group\\_5#/](https://en.wikipedia.org/wiki/Carrier_Strike_Group_5#/)

The younger officer replied with a snap: "certainly we have!"  
Great answer to me. They all know.

- do you consider yourself a conscious person?
  - I answered: hopefully – to a certain degree

One could start musing about this, after reading much about the 'awakening of the spirit'.

Strange. They all know.

I was released in time, missing only lunch, not my plane.



# 28 HOPE not hate

Strictly within the New World Order logic of turning everything upside down – and to distort the meaning of words – 'HOPE not hate' does not mean hope.

The next meeting of the '911Keep Talking group' could not take place, as 'HOPE not hate' – a UK based lobby group – prevented the event.

- generally speaking under attack is: **free speech**



Source @04:38: <https://www.youtube.com/watch?v=8r6UDgWuqgY>

If an organization "campaigns to counter racism and fascism" it should at least stop serving the fascists' interests.

<b>obscure</b>	Keep Talking, run by Ian Fantom, is an obscure London based group for conspiracy theorists of all types ranging from Holocaust deniers, climate change deniers and 9/11 'Truthers'. Past guests include Piers Corbyn, brother of Jeremy, who claimed man made climate change is a 'lie'.	<b>'lie'</b>
<b>conspiracy</b>		<b>9/11 fabricated</b>
<b>truthers</b>		<b>theorists</b>
<b>'false flag'</b>	Kollerstrom has called the 9/11 attack in New York, 'a constructed, fabricated event' and argues that the 7/7 attacks in London were a 'false flag' terror attack. Tonight, he will be giving his conspiratorial take on the recent Westminster attacks in London.	<b>deniers</b>
		<b>'constructed'</b>

Source: <http://hopenothate.org.uk/2017/05/02/>

## 29 Epilogue

Engaging in 9/11 means to uncover, layer by layer, the incredible story of a web of lies, so thick, so impenetrable, so vast, so atrocious, that people simply refuse to believe the web exists.

Each layer of deceit holds its own logic and plot, uncovering it needs courage and conviction, pertinence and spiritual power.

As many dead alleys lie on the way its easy to get lost, to become a victim in the devil's game, turning from the path of truth to the path of the perceived truth.

This false narrative, the perceived truth, is the devil's trap.

It is constantly laid out before us, constantly changed and adapted, constantly refined.

It is easy to become just a tool in the hands of the devil, who yearns for war, violence and vengeance.

There is just one way out: the continuous **and personal** search for truth, justice and peace, which is the only option.

For all of us.

To disarm the devil – and not to serve him.

# Glossary

## A

Anti-matter p. 23

## B

Bathtub p. 24

Building 7 p. 48  
p. 10, p. 8

Bragg Peak p. 105

## C

Cancer p. 76  
p. 14

Caverns p. 26  
p. 104

Collimator p. 57

Critical mass p. 101

## D

DEW p. 23  
Directed Energy Weapon

Dirty bomb p. 13

## E

EMP p. 64  
Electro-Magnetic Pulse

## F

Fission p. 22  
p. 100

Fusion p. 22  
p. 55

## G

Ground Zero p. 16  
p. 18

## H

Hotspots p. 8

## I

Isotopes p. 66

## K

Khalezov-problem p. 17  
p. 22

## M

Mossad p. 78

MRR p. 23  
Minimal Residual Radiation

Mushroom cloud p. 10

## N

Neutron absorption p. 66

Neutron reflection p. 67

Nuclear fizzle p. 55  
p. 27

NWO p. 86  
New World Order

## P

Pyroclastic flow p. 20

## R

Radioactivity p. 12, p. 73  
p. 92, p. 102

Radiation flash p. 54  
p. 68, p. 102

Residual radiation p. 74

## S

Secret society p. 84

Seismic shock p. 28  
p. 55, p. 100

Scintillation p. 14

Solid angle p. 54

Stairwell B p. 95

Steam explosion p. 70

## Dropping the angst

The key element of the oligarchs' mind game is fear – or angst.

On the spiritual side you will always win, dropping the angst:

- trust in your spiritual self



Source: <https://911justicehalifax.files.wordpress.com/2013/12/gjs-wtc28.jpg>

# Special Thanks

I am grateful to all those people who uploaded videos onto YouTube and pictures in Google Images, of which there are too many to mention individually.

The views expressed in this booklet are those of the author only.

I understand that the views expressed in this booklet are not necessarily the same as the views of the original creators intentions of some YouTube videos.

Special thanks to Ian Fantom – founder of the 911Keptalking group – and all individuals who helped directly in making this booklet possible, by their engagement to expose the lies and to stand with the truth.

My sincere gratitude also goes to Dimitri Khalezov for being the first man to expose the real energy source behind the WTC destruction.

# Fair Use

This booklet contains copyrighted material the use of which has not always be specifically authorized be the copyright owner.

I am making such material available in an effort to advance understanding of environmental, political, human rights, economic, democratic, scientific and social justice issues.

I believe this constitutes a 'fair use' of any such copyrighted material as provided for in section 107 of the US Copyright Law.

In accordance with Title 17 U.S.C. Section 107 this booklet and the information it contains is distributed without profit to those who have expressed a prior interest in receiving the included information for research and educational purposes.

Heinz Pommer  
Heidenheim, 2017/09/01

# Available as free copy



[www.911history.de/pdfs/911\\_Analysis\\_en.pdf](http://www.911history.de/pdfs/911_Analysis_en.pdf)

## bitcoin donations – participate !

Every coin goes into publishing and distribution !

bitcoin code:



bitcoin account:

1DDGLybQEmmT9c28Pj6JrdCV7Arsk1yQeh

## Published by

bitplant.de GmbH & Co. ATD-Services KG  
Fabrikstr. 15

D-89520 Heidenheim (Brenz)  
HRA 661148 / HRB 661563





This booklet provides basic information about the destruction of the World Trade Centre on 9/11 by means of sophisticated third generation nuclear weapons, orchestrated by the misguided and abused israeli-american intelligence apparatus.



Source: <https://s-media-cache-ak0.pinimg.com/736x/7d/93/7c/7d937ce48cb6be70407d2d95b963b261--wtc---american-history.jpg>